



Netti[®] **4U CE Plus**

GMDN 41620

User Manual



CE This product conforms to MDR regulation
(EU) 2017/745 for medical products.

UM0101 UK 2022-03

*inspire
joy of life*

CONTENTS

1.	INTRODUCTION	4
1.1	AREAS OF USE / INDICATIONS FOR NETTI 4U CE PLUS / CES PLUS	5
1.2	CONTRAINDICATIONS	5
1.3	QUALITY AND DURABILITY	5
1.4	THE ENVIRONMENT AND WASTE DISPOSAL	6
1.5	INFORMATION FOR RE-USE	6
1.6	ABOUT THIS MANUAL	7
1.7	VITAL MEASURES	7
2.	QUICK REFERENCE	8
3.	DESCRIPTION	9
4.	FEATURES OF NETTI 4U CE PLUS / CES PLUS	10
5.	ACCESSORIES	11
5.1	ASSEMBLING OF HIP BELT	13
6.	ASSEMBLING AND ADJUSTMENT	14
6.1	UNPACKING	14
6.2	MAIN WHEEL	14
6.3	FRONT CASTORS	15
6.4	SEAT HEIGHT ADJUSTMENT	15
6.5	BACKREST	16
6.6	BACKREST CUSHIONS	17
6.7	SEAT DEPTH ADJUSTMENT	18
6.8	ANTI-TIPS	18
6.9	SEAT CUSHION	19
6.10	LEG SUPPORTS	19
6.11	HEAD SUPPORT	22
6.12	ARM SUPPORT	24
6.13	ADJUSTING THE PARKING BRAKES	25
7.	SEAT ANGLE/TILT AND BACK ANGLE/RECLINE	27
7.1	SEAT ANGLE	27
7.2	BACKREST ANGLE	27
7.3	KEY WORDS REGARDING TILT AND RECLINE	28
7.4	DECREASE THE POSSIBILITY OF SLIDING, SHEAR AND PRESSURE SORES	28
7.5	OPERATING TILT HANDLE: TILTING THE SEATING UNIT	29
7.6	OPERATING RECLINE HANDLE: RECLINING THE BACK	30

8.	MANOEUVRING	30
8.1	GENERAL TECHNIQUES	30
8.2	DRIVING TECHNIQUES – STEP UP –	31
8.3	DRIVING TECHNIQUES – STEP DOWN –	31
8.4	DRIVING TECHNIQUES – SLOPE –	32
8.5	DRIVING TECHNIQUES – UP STAIRS –	32
8.6	DRIVING TECHNIQUES – DOWN STAIRS –	33
8.7	TRANSFER	33
8.8	LIFTING THE WHEELCHAIR	34
8.9	PUSH RIM	35
9.	TRANSPORT	36
9.1	TRANSPORT IN CAR	36
9.2	FOLDING FOR TRANSPORT	38
9.3	TRANSPORT IN AIRPLANE	38
9.4	TRAVELING ON PUBLIC TRANSPORT	39
10.	MAINTENANCE	40
10.1	MAINTENANCE INSTRUCTIONS	40
10.2	CLEANING AND WASHING	40
10.3	LONG TERM STORAGE	41
11.	TABLE VITAL MEASURES	42
12.	TROUBLESHOOTING	43
13.	TESTS & WARRANTY	44
13.1	TESTS	44
13.2	WARRANTY	44
13.3	CLAIM	45
13.4	NETTI CUSTOMIZED / INDIVIDUAL ADAPTATIONS	45
13.5	COMBINATIONS WITH OTHER PRODUCTS	46
13.6	SERVICE AND REPAIR	46
14.	MEASUREMENTS & WEIGHT	47

1. INTRODUCTION



Netti 4U CE PLUS / CES PLUS are comfort wheelchairs meant for both indoor and outdoor use. They are tested to DIN EN 12183:2014. The tests were carried out by TÜV SÜD Product Service GmbH in Germany.

In Alu Rehab we believe that wheelchairs should be chosen based on a thorough assessment focusing on the needs of the user and demands from the environment. Therefore, it is important to know about the possibilities and restrictions of the wheelchair. Netti 4U CE PLUS and CES PLUS are wheelchairs designed for users with the need for comfort and relief. The combination between the seating system and the ergonomical solutions in the frame construction, offers many possibilities for adaptation and adjustments.

The wheelchairs are constructed for indoor and outdoor use, and offers the possibility to vary the sitting position from activity to rest using tilt and recline functions.

Netti 4U CE PLUS is available in 2 versions:
Netti 4U CE PLUS with standard seat depths.
Netti 4U CES PLUS for users with need for shorter seat depth.

Max user weight: 135 kg.



When mounting accessories such as power kit etc., the weight of the accessories must be subtracted from the max user weight.



Specifications varies between countries.



Netti 4U CE PLUS wheelchair is identified in the Global Medical Device Nomenclatura GMDN 41620 Wheelchair attendant / occupant driven, rear wheels driven, non-collapsible.

1.1 AREAS OF USE / INDICATIONS FOR NETTI 4U CE PLUS / CES PLUS

Netti 4U CE PLUS / CES PLUS are multifunction wheelchairs for partially or fully immobile youth and grown up persons with physical and / or mental disabilities. These disabilities may have multiple causes.

Netti 4U CE PLUS / CES PLUS have an adjustable seat and back angle, thus facilitating for the user change of position, mobilisation or posture correction (stabilisation), wherever the following functional impediments with their multiple possible causes are present:

- limited or lacking mobility
- limited or lacking muscle power
- limited movement range
- lacking or limited trunk and body stability
- hemiplegia
- rheumatic-type disorders
- craniocerebral injuries
- amputations
- other neurological or geriatric disorders.

1.2 CONTRAINDICATIONS

Netti 4U CE PLUS / CES PLUS are not suited for persons with a strongly enhanced muscular spasticity. In this case we recommend the Netti Dynamic System, which offers a frame construction that follows the movement pattern of the user. Ignoring this advice could in unfavorable circumstances lead to the deformation or fracture of metal parts in the area of the back tube, the leg support or the arm support.

1.3 QUALITY AND DURABILITY

The Netti 4U CE PLUS / CES PLUS wheelchairs are tested at TÜV SÜD Product Service GmbH in Germany, following the European Standard DIN EN 12183:2014.



As manufacturer, Alu Rehab A.S evaluates the test to be equal to 5 – 6 years of normal use of the chair. The disability of the user as well as the level of maintenance done foremost decides the durability of the wheelchair. Thus, the durability will vary depending on these two factors.

1.4 THE ENVIRONMENT AND WASTE DISPOSAL

Alu Rehab and its suppliers wish to protect the environment.



This means:

- That we avoid using environmentally harmful substances and processes to the greatest extent possible.
- That Alu Rehab's products are ensured a long service life and a high degree of flexibility – to benefit the environment and economy.
- That all packaging can be recycled.
- That the wheelchair was designed to be separated into its component materials – to make recycling easier.



Contact your local recycling agent to get correct information how to handle in your area.



Netti 4U CE PLUS / CES PLUS are designed for temperature range from -10°C to +40°C.

1.5 INFORMATION FOR RE-USE

All products from Alu Rehab are designed to give years of maintenance-free service. All products can be adapted for re-use by an authorised dealer. In order to guarantee performance and safety, Alu Rehab recommends the following tests prior to any re-use.

Please examine the following components for function, integrity etc. and replace parts as necessary:

- Wheels (tyre tread)
- Wheelchair frame
- Front castors and quick release
- Hubs
- Brake function
- Directional stability of wheels
- Bearings: test for wear and lubrication
- Cushions
- Leg supports
- Arm supports
- Recline / tilt function
- Push bar / handles
- Anti-tip

Please also note the content of chapter 10.2 Cleaning and care.

For hygienic reasons: please replace the head support for a new user.

ANTI-TIP

Correctly fitted, the anti-tip will secure the chair from tipping backwards. We strongly recommend use of the anti-tips.

Latest user manual updates, product safety notes, addresses and other product information like recalls etc. will be published on our web page.

1.6 ABOUT THIS MANUAL

In order to avoid damages while using the Netti 4U CE PLUS / CES PLUS wheelchair, please read this manual carefully before starting to use the chair.



Symbol of forbidden actions. No warranty can be claimed whenever these actions are implemented.



Symbol of warning. Whenever this symbol is used, caution has to be taken.



Symbol for important information.



Symbol for useful tips.



Symbol for tools.



Symbol for parking brake safe slope.



Max.
135 kg

Symbol for max user weight.



Symbol for medical device



Manufacturer: name + address



Date of manufacturing



Product serial number



Read Instruction

Please note that this manual is updated according to the year and date stated on each page.

User Manual on web www.my-netti.com

For enhanced readability (advantageous for users with visibility challenges) please find our user manual on our web page: www.My-Netti.com – manuals – user manual Netti 4U CE PLUS / CES PLUS.

1.7 VITAL MEASURES

Netti 4U CE PLUS and CES PLUS are comfort wheelchairs designed for both outdoor and indoor use.



Specifications varies between countries.

TOTAL WEIGHT: 28,5 KG
(450 mm width chair)

SEAT WIDTH:

350, 400, 450, 500 mm



SEAT DEPTH:

(From backrest cushion to front of seat plate)



CE PLUS: 425, 450, 475, 500 mm

CES PLUS: 375, 400, 425, 450 mm

SEAT HEIGHT:

(From floor to top seat plate using 24" main wheels in upper hole position)



465 mm*

* By changing position of main wheels, it is possible to achieve seat height of 500 mm.

BACKREST HEIGHT:

500 mm*



* Using backrest extender gives backrest height of 600 mm.

A table with wheelchair dimensions is found on page 42.

Netti 4U CE PLUS and Netti 4U CES PLUS are identical chairs except for the shorter seat depth by Netti 4U CES PLUS.

2. QUICK REFERENCE

The content of this page is a summary of the whole manual. It gives you a brief introduction to the use and care of the Netti 4U CE PLUS / CES PLUS wheelchair.

 **The quick reference is not a replacement for the manual, only reminder / check list.**



- Unpack the wheelchair (Chapter 6.1).
- Mount the main wheels (Chapter 6.2).
- Mount the front castors (Chapter 6.3).
- Put the backrest back, and mount the recline as strut to the backrest using the locking bolt. (Chapter 6.5).
- Mount the arm support (Chapter 6.11).
- Mount the seat cushion (Chapter 6.9).
- Mount the leg supports (Chapter 6.10).
- Mount the head support (Chapter 6.11)
- Set anti-tip in active position (Chapter 6.7).
- Mount accessory (See chapter 5 for more information. Mounting descriptions will accompany the accessory.).

ADJUST THE WHEELCHAIR TO THE USER:

Adjust seat depth and eventually the wheelchair balance, leg support height, arm support height, head support height and depth, chair back cushion height.

For more information about adapting the wheelchair to the user please see:

www.My-Netti.com knowledge centre.

-  **Announcements to product safety and eventually product recalls will be published on our home page www.My-Netti.com.**
-  **For troubleshooting, see chapter 10. For mounting and adjustments see chapter 6.**
-  **For visually impaired people, manuals and catalogues can be downloaded at www.My-Netti.com.**

 **Drive carefully!**

 **Be aware that friction against pushrims can create a warm surface.**

 **Surface temperature of metal parts in frame structure might increase when exposed to direct sunlight.**

 **Salt water can increase risk of corrosion further precautions related to environmental conditions not needed.**

 **The anti-tips should always be used for the safety of the user.**

 **When the chair is tilted rearwards, the anti-tips and brakes must always be in use.**

 **Be sure to lock all handles properly.**

 **Watch out for pinching danger when folding and unfolding, tilting, reclining and all other adjustment movements.**

 **Never stand on the foot plates due to risk of tipping forwards.**

 **Never lift the wheelchair by the leg supports, arm supports or head support.**

 **Product configuration may vary between different countries.**

 **Illustrations may differ from the delivered product.**



 **If in doubt – contact your dealer!**

3. DESCRIPTION

Standard version*

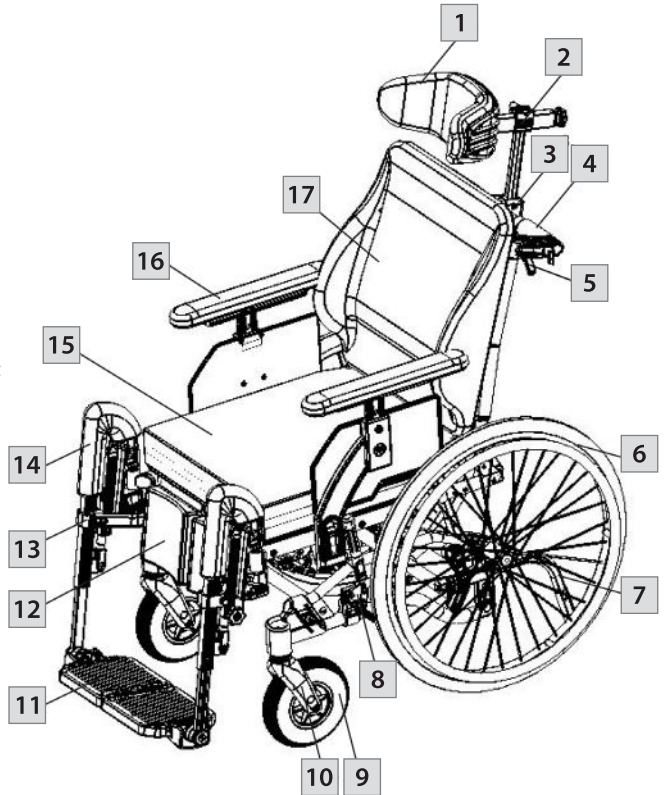
1. Head support
2. Angle and depth adjustment for head support
3. Head support bracket
4. Push bow
5. Release handle
6. Main wheel
7. Anti-tip
8. Brakes
9. Front castors
10. Front fork
11. Foot plate
12. Calf support
13. Calf support bracket
14. Angle adjustable leg support
15. Seat cushion
16. Arm support with pad
17. Back cushion



-  If any of these parts are missing, please contact your dealer.
-  Product configuration may vary between different countries.
-  Netti 4U CE PLUS and Netti 4U CES PLUS are identical chairs except for the shorter seat depth by Netti 4U CES PLUS.

4. FEATURES OF NETTI 4U CE PLUS / CES PLUS

STANDARD

SEAT

- Pressure distributive cushion Netti Uno
- Tilt -5° to $+20^{\circ}$
- Adjustable seat depth 75 mm

WHEELS

- 24" x 1 3/8" puncture proof main wheels with quick release axle
- Push rim: Aluminum
- 7" Puncture proof front castors with quick release axle

Standard main wheels may vary between countries.

PUSH HANDLE

- Angle adjustable push handles

BRAKES – User Brakes

ANTI-TIP – Upwards swingable

BACKREST

- Angle: 90° to 135°
- Height: 500 mm
- Netti Uno Back

LEG SUPPORT

- Universal or angle adjustable leg support
- Height and angle adjustable foot plates
- Removable

ARM SUPPORT

- Height adjustable
- Removable

HEAD SUPPORT

- Height, depth and angle adjustable
- Removable

ACCESSORIES

BELTS

- Hip belts (See chapter 5)

SEAT

- Pressure distributive cushions

WHEELS

- Puncture proof PU wheels 12", 16" and 24x1" with drum brake (See chapter 5)
- Puncture proof PU 22 x 1" & 24 x 1"
- 6" & 7" puncture proof front castors with quick release axle
- Pneumatic wheels

PUSH BOW

- Height and angle adjustable push bow

BRAKES – Drum Brakes

BACKREST

- Backrest extender (See chapter 5)
- Lumbar support and wedge (See chapter 5)
- Different backrest cushions

LEG SUPPORT

- Amputation support
- Upholstery for foot supports

ARM SUPPORT

- Hemi cushions (See chapter 5)

HEAD SUPPORT

- Different head support models (See chapter 5)

5. ACCESSORIES



The anytime updated complete accessory and spare part catalogue can be downloaded from our home page www.My-Netti.com order forms.

FRAME

ANTI-TIP

With tramp pedal.

BRAKE EXTENDER

Long 310 mm.

FRAME EXTENDER

Increases distance between main wheels and front castors.
Reduces tipping risk.

EYE BOLT SET

For fixing wheelchair in a car.

BACK

BACKREST CUSHIONS

Several models.
Please contact your dealer.

WEDGE

Increases side support.

LUMBAR SUPPORT

Increases lumbar curvature.

BACKREST EXTENDER

120 mm extender. To be used together with 600 mm backrest cushion. Watch out that the chair does not become unstable when the back is reclined.



SIDE SUPPORT CORRECTION.

Meant for correction of bad postures in the upper trunk.

PAD

For side support

SIDE SUPPORT STABLE

Meant for users with decreased stability of the upper trunk. For optimal function use together with Stable cushion.

PAD

For side support Stable

SEAT

SEAT CUSHIONS

Many to choose from.
Please contact your dealer.

PELVIC STABILIZER

ABDUCTION BLOCK

The block reduces abduction.

Small: 80 mm width
Medium: 110 mm width
Large: 140 mm width

BELTS AND HARNESSSES

Several models:
Hip belts with or without upholstery and with plastic lock or car lock
(Chapter 5.1 for mounting).

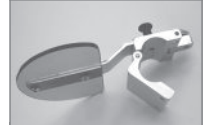

HEAD SUPPORTS

SUPPORT A

Side support
(also with head band).

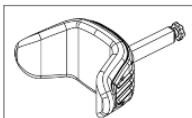

SUPPORT B

Small.

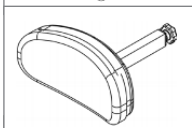

SUPPORT C

Large.

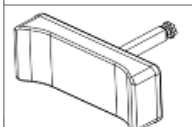

SUPPORT D

Comfort.

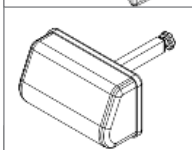

SUPPORT E

Side support.

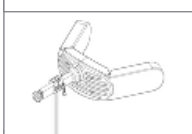

SUPPORT F

Cheek support.



HYGIENE COVER

Protects the core of the head support.



HEAD CUSHION

40 x 40 cm cushion with Kospoflex filling and rubber band.



HEAD CUSHION COMFORT

Cushion with Kospoflex filling to pull onto head rest.



ARM SUPPORT

HEIGHT ADJUSTMENT



HEMI ARM SUPPORT

A support for hemiplegic users.



LEG SUPPORT



ANGLE ADJUSTABLE



UNIVERSAL LEG SUPPORT

Adjustable in fixed positions between 33° to 105° using an adjustment wheel.



AMPUTATION SUPPORT



UPHOLSTERY FOR CALF SUPPORT BRACKET

Reduces pressure.



CALF PAD HINGED

The user doesn't have to lift the leg when mounting or dismounting the foot supports.



FOOT BOARD WITH LOCK

The foot support can be swung to the side like standard foot supports.



ANKLE HUGGERS

WHEELS

MAIN WHEEL

12" & 16" and 24"
with drum brake.

FRONT CASTORS

7" – 175 x 45 Flexel.

SPOKE PROTECTORS

For 20", 22" and 24".
Transparent.

TRAYS etc.

2 MODELS

Swingable and
lockable.

UPHOLSTERY FOR TRAY

Offers a soft base for the arm
resting on the tray.

TOOL SET

INFUSION STAND

To be fixed to the horizontal
chair back tube.

 The spare part and accessory catalogue can be downloaded from our home page [www. My-Netti.com](http://www.My-Netti.com) downloads – orderforms.

<http://www.my-netti.com/docs/order-forms/order-form-netti-4u-comfort-ce-plus>

5.1 ASSEMBLING OF HIP BELT

- Pull the belt through the hole in the hip belt bracket.



- Thread the belt back through the belt clamp.



- Fix the hip belt bracket to the backrest hinge in the rearmost hole, using the enclosed screws and nuts.

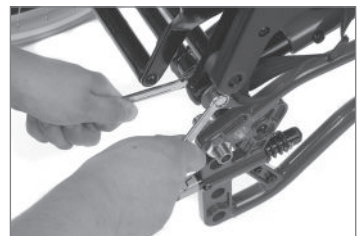

-  2 pcs 13 mm open-end spanner.

6. ASSEMBLING AND ADJUSTMENT

i For information about adapting the wheelchair to the user, please see: [My-Netti.com Knowledge center](http://My-Netti.com).

Tools needed are described under each chapter. Accessories described in chapter 5 is a presentation of options and will be delivered with separate mounting descriptions.

6.1 UNPACKING

1. Unpack all the parts, and check that everything is there according to the packing list.
2. Mount the main wheels (Chapter 6.2).
3. Mount the front castors (Chapter 6.3).
4. Check and adjust the seat depth (Chap. 6.7).
5. Mount the backrest (Chapter 6.5).
6. Mount the arm supports (Chapter 6.12).
7. Mount the seat cushion (Chapter 6.9).
8. Mount the leg supports (Chapter 6.10).
9. Mount the head support (Chapter 6.11).
10. Mount any accessories (Chapter 5).

Weight of components (450 mm chair width):

Main wheels:	1,9 kg each
Anti-tip:	0,1 kg each
Front castors:	0,8 kg each
Leg support angle adj.:	2 kg each
Netti Seat cushion:	1,0 kg
Head support A:	1,0 kg
Head support C:	0,9 kg

6.2 MAIN WHEEL

To mount the main wheel remove the quick release bolt from the hub bushing. Lead it through the centre of the main wheel and into the hub bushing while pressing the knob in centre.



- !** To check that the main wheel is properly attached to the hub, remove the finger from the central knob and pull at the main wheel.
- X** If the main wheel doesn't lock, do not use the wheelchair but contact your dealer.
- !** Sand and sea water (salt used for gritting in the winter) can damage the bearings of the main wheels and front castors. Clean the wheelchair thoroughly after exposure.

6.3 FRONT CASTORS

Are equipped with quick release axle.

To take off:

- Press the release button under the silicon cap on top of the front fork bearing house.

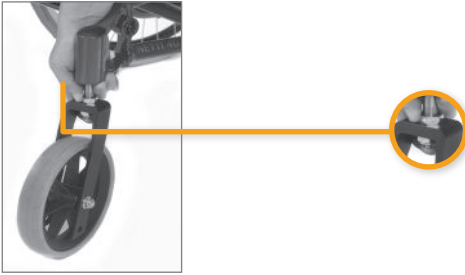

To mount:

- Lead the quick release axle into the bearing house. Pull the fork slightly to ensure that the fork is fully locked.



6.4 SEAT HEIGHT ADJUSTMENT

The seat height at the rear depends on:

- Size of main wheel.
- Position of main wheel.
- Using 24" main wheels in the upper hole, the seat height is 465 mm from the floor to the seating plate. Using 24" main wheels in the next lower position, the height will measure 500 mm to the seating plate.

If it is required to change position of the main wheels or to change to a different size of main wheels, unfix the hub bushing including washer and nut. Remove the hub bushing and mount it in the required position.



2 pcs 24 mm open-end spanners.



Make sure that the nut on inside of frame totally wreathes the wheel bushing.

Main wheels and front castors should be mounted according to the positions described below.

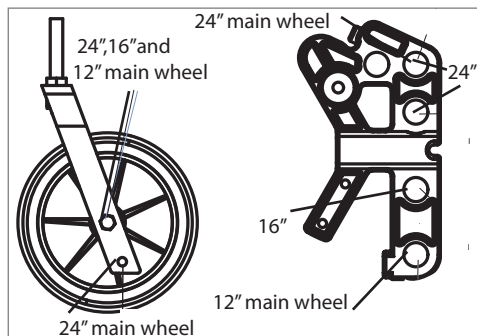

⚠ When the seat height is changed ensure that the front castors are positioned so that the front castors bearing houses stands vertical to the ground. This is vital to have good wheelchair driving characteristic.

⚠ Check the position of the anti-tip and readjust the brakes after mounting the main wheels or changing the main wheel position.

6.5 BACKREST

- To mount the gas spring, lift the push bow with one hand, and lead the gas spring locking head into the plastic bracket with the other.
- Check that the hole in the locking head is parallel with the open holes in the plastic bracket.



- Lock the backrest by pushing the locking bolt through the plastic bracket and gas spring locking head.



- ⚠** To check that the backrest is locked, grip the push bow and press the backrest forward. If the backrest falls forward – repeat the locking procedure or contact your local dealer.

6.6 BACKREST CUSHIONS

- The wheelchair is set to a standard seat depth, and the plastic bracket has 4 holes of which three are temporarily blocked with plastic plugs.



- The backrest hinge has 4 holes. The hole positions are in accordance with the holes in the plastic bracket. If the locking head of the gas spring is mounted in the inner hole of the plastic bracket, the backrest hinge should also be mounted in the inner hole etc.



The backrest comes with a one piece Velcro back as standard.



Backrest cushions are attached with a Velcro system.



It is imperative to correctly set-up the cushion in order to ensure good seating comfort.



The cushion covers are washable and thereby reusable. Follow the instruction on the back of the cushion for correct maintenance and washing of the cushion.

6.7 SEAT DEPTH ADJUSTMENT

- If the seat depth can only be adjusted at the rear, loosen the locking bolt in the plastic bracket.
- Find the required position for the locking head in the plastic bracket, and remove the plastic plug from this hole.
- Lock the backrest by pushing the locking bolt through the plastic bracket and the gas spring locking head.
- After changing the hole position in the plastic bracket, the hole position in the backrest hinge must be changed into the parallel position.

 **Check that the hole in the backrest hinge and the plastic bracket are mounted into the same hole position.**

 **6 mm Allen-key.**

6.8 ANTI-TIPS

The anti-tips should be mounted according to the mounting description which is enclosed with the chair upon arrival.

USE OF THE ANTI-TIP

- Pull the anti-tip out.
- Turn it up or down 180°.
- Lock it in position.



ADJUSTING THE HEIGHT OF THE ANTI-TIPS

The anti-tip can be adjusted in two fixed positions. The short position is for 12" & 16" main wheels and 24" in upper position. The long position is for 24" main wheels in lower position.

- Unfix the screw in the adjustable extension piece as shown in picture below.
- This extension piece has two holes. Place it in the required position and tighten the screw.



 **5 mm Allen-key.**

 **The anti-tip should always be used for the safety of the user.**

6.9 SEAT CUSHION

The seat cushion is fixed on the wheelchair with Velcro.



 It is very important to place the cushion in the wheelchair before use.

 The cushion cover is washable and reusable. Follow the instruction on the back of the cushion for correct maintenance and washing of the cushion.

6.10 LEG SUPPORTS

Netti 4U CE Plus and CES PLUS can be delivered with either Universal or Angle Adjustable leg support.

UNIVERSAL LEG SUPPORT

The Universal leg support is fixed with the possibility for angle adjustment. It is swingable and removable. The foot plates are foldable and can be angled in fixed positions. It is delivered with height and depth adjustable calf support.



ANGLE ADJUSTABLE LEG SUPPORT

The angle adjustable leg support is freely adjustable in angle. It is swingable and removable. The foot plates are foldable and can be angled in fixed positions. It is delivered with height and depth adjustable calf support.

MOUNTING OF LEG SUPPORT

- Mount the leg support by holding onto the top of the curved bar.
- Hold it in an angle of app. turned 20° outwards from the side frame.
- Insert it into the black plastic lock for the leg support.
- Swing it inwards and push down.

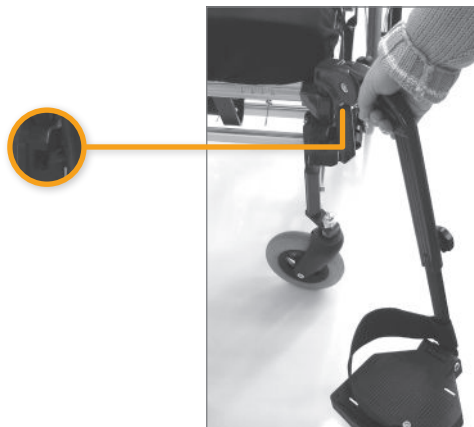

Adjusting the angle – Angle adjustable leg support

The angle of the leg support can be adjusted using the star wheel.

- Loosening this star wheel enables you to adjust the leg support to the required angle.
- Fix the angle by tightening the star wheel.



Adjusting the angle – Universal leg support

The angle of the leg support can be adjusted using the star wheel in center of the hinge point.

- Loosening this star wheel enables you to adjust the leg support to the required angle.
- Fix the angle by tightening the star wheel.

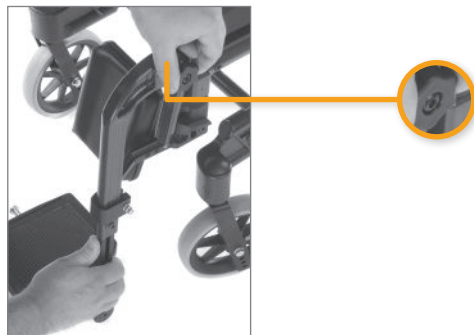

Squeeze hazard.

When adjusting leg supports angle, do not put the fingers in the adjusting mechanism between the moving parts.



Adjusting the length of the leg support

- Loosen the screw (A) ill. next page, to make the adjustment tube move.
- Adjust the foot plate to required height / position and fix the screw tightly.

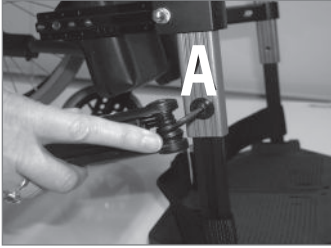

Adjusting the angle of the footplate

The foot plates angle can be adjusted.

- Untighten the screw (B) and adjust the foot plate to the required angle. Fix the screw properly.

 5 mm Allen-key.



Locking and releasing the foot plates

- The foot plates come with a locking mechanism which makes the plates stronger.
- To lock the foot plates pull the plastic lock on the right foot plate and place the lock over the bolt on the left foot plate.
- To release the foot plate pull the plastic lock and lift the right foot plate up.

 For outdoor use, there should be a clearance of 40 – 50 mm between the foot plate and the ground.





 While making the adjustment there must be no load on the foot plates.

REMOVING THE LEG SUPPORT

- Pull the plastic lock on the foot plate rearwards, so that the pin is released, and the foot plate can be folded up.
- Release the leg support by pulling it slightly straight up.
- Swing the leg support outwards.
- Lift and remove the leg support.



 Never stand on the foot plates!

 Never lift the wheelchair by the leg supports.

6.11 HEAD SUPPORT

Adjusting the calf support

The calf support is height and depth adjustable. To adjust height unfix the nut on the outside of the calf support bracket, find the required height and fix the nut again (A).

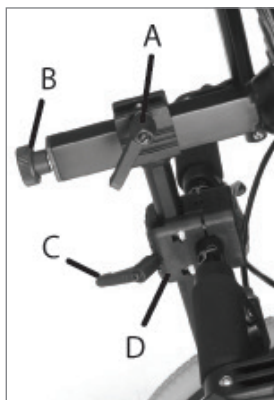

- A – Lever for depth adjustment
- B – Wheel for angle adjustment
- C – Lever for height adjustment
- D – Head support bracket

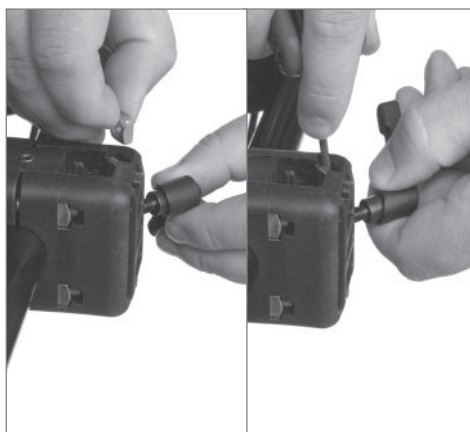
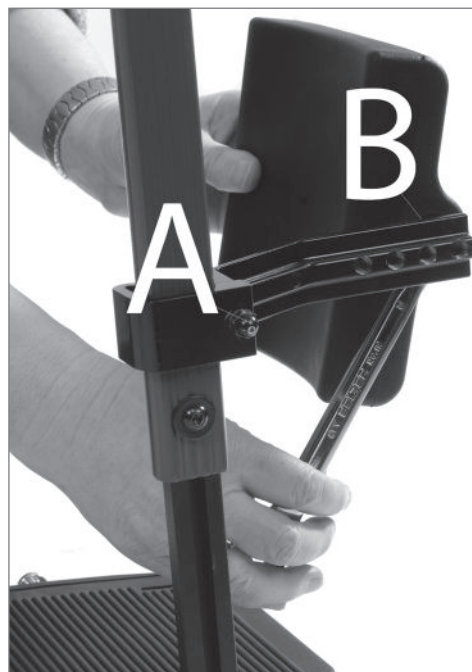

To adjust in depth, the calf pad is removed from the bracket by using an open-end spanner between the pad and the bracket. Find the required position and refix it.

 **13 mm open-end spanner.**

- Place the squared nut in the slot of the head support bracket as shown above.
- Place the head support in the head support bracket.
- The height and the depth of the head support is set to the required positions and tightened.



The head support bracket is fixed by tightening the four screws two by two diagonally so the bracket is fixed with the same strength divided on the four screws.

Adjusting the head support in depth:

- Release the locking lever on top of the vertical bar (A).
- Adjust the head support and fix it in required position.

Adjusting the head support in height:

- Release the locking lever on the head support adapter (C).
- Adjust the head support and fix it in required position.

Adjusting the head support in angle:

- Release the adjustment wheel at the rear of the horizontal bar (B).
- Adjust the head support and fix it in required position.

Adjusting the head support sideways:

- The head support adapter can be moved both to the right and left, giving the possibility to accommodate special needs for head support.
- Untighten the four screws holding the adapter together.
- Move the adapter to the required position and fix the adapter by tightening the screws diagonally.



Remember to release the levers when adjusting the head support.



If the head support stand does not fit the bracket perfectly, the bracket is probably fixed too tight or unevenly.



After fitting the head support fix it properly by tightening the little set screw in the centre on top of the head support bracket using an Allen-key.



If the head support seems to short in height, it can be turned 180° by releasing the adjustment wheel at the rear of the horizontal bar (B).

6.12 ARM SUPPORT



- The arm supports are removable, height and depth adjustable.

 **Please be aware while mounting that there is a left-hand-side and a right-hand-side arm support.**

Adjusting the height of the arm support

- Untighten the screw on the arm support using a 6 mm Allen-key.
- Raise or lower stem.
- Tighten the screw.



Mounting the arm support

- Grip the arm support and pull straight up in a vertical direction from the insert sleeve.

 **An additional lock for the arm support can be ordered as an accessory.**

 **Never lift the chair holding onto the arm supports.**

6.13 ADJUSTING THE PARKING BRAKES

- The brakes are freely adjustable along the frame tube.
- To activate the brake, push the handle.
- To release the brake, pull the handle rearwards.



- To reposition the brake, loosen the two screws on the inside of the brake clamp.

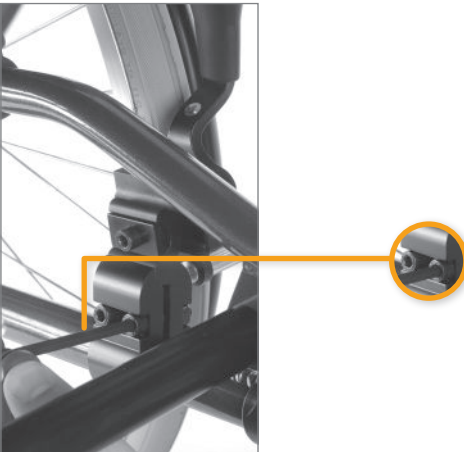

- Adjust the brake position and tighten the screws.
- For fine adjustment, loosen the upper screw on the inside of the brakes.

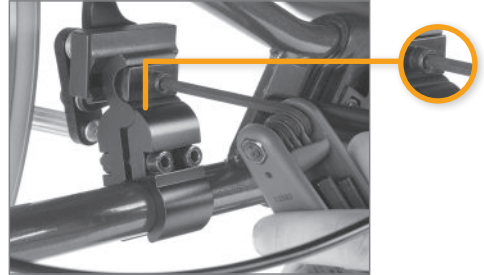

- Adjust the brake position and tighten the screw.



5 mm Allen-key.



Check that the brakes are correctly adjusted by activating the brakes and be sure that the wheelchair does not move.



The brakes are constructed as parking brakes and shall not be used as driving brakes.



Be aware of potential squeeze hazard between brake and tyre.

DRUM BRAKE

If the wheelchair is mounted with 12" or 16" main wheels, these will be equipped with drum brakes. 22" and 24" wheels can also have drum brakes.

If the brake does not brake properly:

To adjust the wire on one or both sides, adjust the foot screw 2 – 4 rounds out. Then recheck the brakes.



If the wire is too loose:

- Adjust the foot screw all the way in.
- Tighten the wire by loosening the wire clamp before pulling the wire further through it.
- Tighten the wire clamp, and adjust the foot screw out again.



1 pc 10mm open-end spanner.



To ensure the correct functions of the wire, these must never be taut.

Operating and applying the brake

The wheelbase with drum brake is fitted with hand operated hub brakes to allow regulation of speed on hills and whilst travelling along. These are located on the push handles.

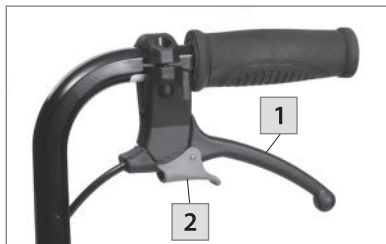

- To apply the brakes, pull the brake levers (1) evenly and smoothly towards handle and bring the wheel-base to a stop.
- For locking the brake in parking position, press the lever (1) against the push handle and push the lever (2) away from you wedging the park brake lever. Make sure both parking brakes are locked.
- The brake will be released when you press the lever (1) against the push handle again. It is locked with a spring and this will in this way be released.





Do not leave the user alone in the wheelchair without putting the parking-brake in function.

7. SEAT ANGLE/TILT AND BACK ANGLE/RECLINE

7.1 SEAT ANGLE

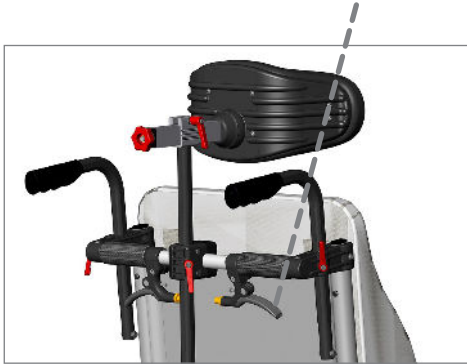

The seat angle is regulated using the release handle mounted on the push bar.
The seat unit can be tilted from -5° to $+20^{\circ}$.



 If you adjust the seat tilt below 0° , there is an increased risk of slipping forward out of the chair. Alu Rehab recommends the use of a hip belt to prevent falling out of the chair.



7.2 BACKREST ANGLE

The backrest angle is regulated using the release handle mounted on the push bar. The angle can be regulated from 90° forward to 45° backwards.

-  To ensure correct function of the wires, these must never be taut.
-  The seat and backrest angle must not be adjusted without using the anti-tips.

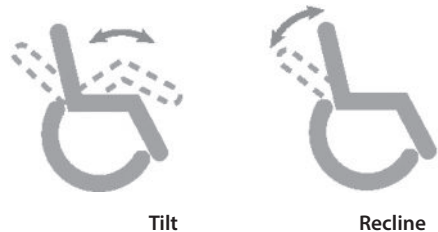
The release handles has each one of the following label:



-  Risk for tipping. Check the position of anti-tip.
-  When chair back extension is mounted, the tipping risk increases. If necessary it should be improved by moving the main wheels further back. Always use anti-tippers when recline and tilt functions are being activated.

7.3 KEY WORDS REGARDING TILT AND RECLINE

OF STATIC COMFORT WHEELCHAIRS, AND COMMON FEATURES OF DYNAMIC WHEELCHAIRS

Tilt and recline are the basic benefits of a comfort wheelchair. It allows for varying seating positions during the time in the wheelchair.

We have reviewed the clinical evidences regarding tilt and recline, and found there are several studies or best practice guidelines suggesting that the tilt and recline sequence is important to reduce shear and sliding:

First tilt then recline afterwards.

When bringing the client upright again, the sequence should be recline first then tilt. It would seem that the most shear would be induced when going upright from a recline and tilted position.

7.4 DECREASE THE POSSIBILITY OF SLIDING, SHEAR AND PRESSURE SORES

Only use the tilt angle to achieve variation of the seating position for the user. It is common knowledge that recline should not be adjusted after the back angle is accommodated to the user's best seating position.

The muscle tone of the neck and back should be as low as possible for the user to prevent sliding, and a change of the recline angle from the original position will interrupt and destroy the correct body position, and cause an increased muscle tone in the neck.

If the recline function is used during a transfer situation or other situations, it is very important that the recline angle is adjusted back to the correct, original position when the user is back to a normal seating position.

Wrong usage of recline causes an increased possibility of sliding, and this means an increased danger of shear (vertical and horizontal forces) and pressure sores.

ASSURE THAT THE USER IS SAFE WHEN THE TILT OR RECLINE FEATURES ARE GOING TO BE ADJUSTED:

The tilt and recline functions of all Netti comfort wheelchair models is a «one hand operation», including the dynamic wheelchair models. This is a great benefit for the user. The care giver is able to establish eye contact with the user when the tilt or recline function is going to be used. The care giver is also able to communicate with the user before the tilt or recline function is used. The user will feel more safe when he / she is aware that the tilt or recline function is going to be used.

7.5 OPERATING TILT HANDLE: TILTING THE SEATING UNIT

Press the left handle on the push bar and put pressure to the push bar to tilt the seating unit with one of your hands, while you have eye contact with the user and put the other hand on the arm support.

The correct relative angle between the body parts remain the same when the seating unit is tilted.

Wherever you let the handle loose, the seating unit will stay in this position. To bring the seating unit up, press the handle and the tilt cylinder will assist you lifting the seating unit up.

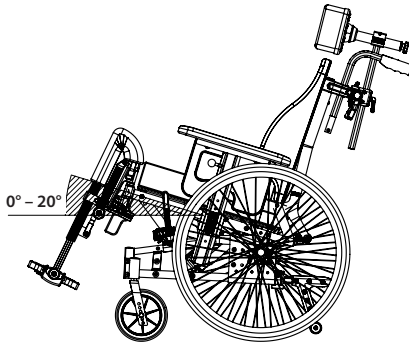

A backward tilted seat unit gives a steeper seating angle in relation to the surface, and prevent sliding of the wheelchair user.

A forward tilted seat unit brings the user in a position where activities – for instance by a table or by standing up from the wheelchair, are supported.

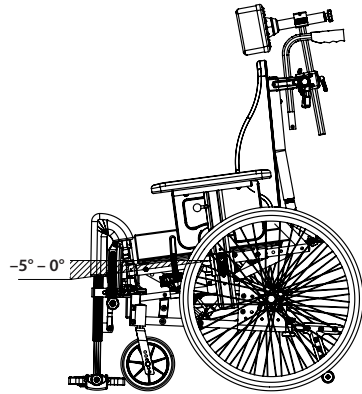

The tilt handle and the tilt sign is on the push bar – shown on the previous page.



Do not leave the user alone in the wheelchair when it is tilted forward. We recommend using a hip belt to prevent sliding out of the chair.

8. MANOEUVRING

7.6 OPERATING RECLINE HANDLE: RECLINING THE BACK

Press the right handle and put pressure to the push bar to recline the back with one of your hands, while you have eye contact with the user and put the other hand on the arm or leg support. Wherever you let the handle loose, the chair back will stay fixed and locked.

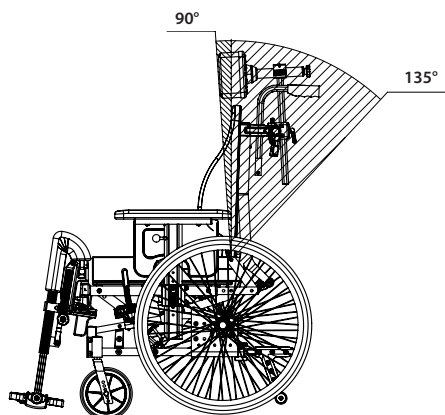

8.1 GENERAL TECHNIQUES

Manoeuvring and chair balance:

The weight and balance of the chair influences the maneuvering qualities of the wheelchair. The weight, size and sitting position of the user are influencing factors. The position of the wheels will in addition influence the manoeuvring qualities. The more weight placed over the main wheels, the easier it is to manoeuvre. If heavy weight is placed over the front castors, the chair will be heavy to manoeuvre. See page 18 – seat depth adjustment – for balancing the chair.



Step approach:

Always approach the step in slow motion preventing the front castors to hit the step with force. The user could fall out of the chair by the impact. The front castors could be damaged.



Driving down steps / sidewalks:

Be cautious that you do not drive down steps higher than 30 mm. The leg supports may hit the ground first. Thereby you may lose steering control and the leg supports may brake.



Driving on soft, rough or slippery ground can make safe manoeuvring more difficult as the wheels may lose traction and it is difficult to control the wheelchair.



Parking:

Increase the footprint and the support of the wheelchair by moving the chair about 100 mm rearwards making the front castors turn forward.



Companion:

If the user is left alone in the wheelchair, always lock the brakes and check that the anti-tips are turned down.

8.2 DRIVING TECHNIQUES – STEP UP –

Companions, drive up a step forwards:

- Check that the anti-tip is turned up.
- Angle the wheelchair backwards.
- Balance the chair on the mainwheels and push it forward until the front castors are on the step.
- Lift the push handles while pushing the chair onto the step.

 **Turn the anti-tip downwards.**

Users, drive up a step backwards:

This technique is only useful if the step is very low. It also depends on the clearance between the foot plates and the ground.

- Check that the anti-tip is turned up.
- Drive the chair backwards towards the step.
- Make a firm grip on the push rims and move the body forward while pulling.

 **Turn the anti-tip downwards.**

Companions, drive up a step backwards:

- Check that the anti-tip is turned up.
- Pull the chair backwards next to the step.
- Angle the wheelchair backwards, moving the front castors slightly up in the air.
- Pull the wheelchair up the step and go backwards long enough to put down the front castors on the step.

 **Turn the anti-tip downwards.**

8.3 DRIVING TECHNIQUES – STEP DOWN –

Companions, drive down a step forwards:

- Check that the anti-tip is turned up.
- Angle the wheelchair backwards, moving the front castors slightly up in the air.
- Drive carefully down the step and angle the wheelchair forward putting the front castors back on the ground.

 **Turn the anti-tip downwards.**

Companions, drive down a step backwards:

- Check that the anti tip is turned up.
- Move the wheelchair backwards to the step.
- Drive carefully down the step and move the wheelchair backwards on the main wheel until the front castors have come away from the step.
- Put the front castors down on the ground.

 **Turn the anti-tip downwards.**

8.4 DRIVING TECHNIQUES – SLOPE –

Important advise for driving down and uphill avoiding the risk of tipping.

 **Avoid turning the wheelchair in the middle of a slope.**

 **Always drive as straight as possible.**

 **It is better to ask for assistance than taking risks.**



Driving uphill:

Move the upper part of the body forwards in order to maintain the balance of the chair.

Driving downhill:

Move the upper part of the body backwards to maintain balance of the chair. Control the speed of the chair by clutching the push rims. Do not use the brakes.

8.5 DRIVING TECHNIQUES – UP STAIRS –

 **Always ask for assistance.**

 **Never use escalators, even if assisted by a companion.**

With assistance, backwards:

- Check that the anti-tip is turned up.
- Pull the wheelchair backwards to the first step of the stairs.
- Angle the wheelchair backwards on the main wheels.
- Pull the wheelchair slowly up the stair, one step at the time keeping the balance on the main wheel.
- Reaching the top of the stair, pull the wheelchair backwards far enough to put the front castors safely down on the floor.

 **Turn the anti-tip downwards.**

 **If two companions are present, one person can assist lifting in the front of the frame.**

 **Do not lift the wheelchair holding onto the leg supports.**

 **Do not lift the wheelchair holding onto the arm supports.**

 **The companions should use the strength in their legs carrying the chair, avoiding unnecessary stress on the back.**

8.6 DRIVING TECHNIQUES – DOWN STAIRS –

-  **Never use escalators, even if assisted by a companion.**

With assistance, forwards:

- Check that the anti-tip is turned up.
- Drive the wheelchair forward to the first step of the stair.
- Angle the wheelchair backwards on the main wheels.
- Have a firm grip on the push bow, and keep the balance on the main wheel taking one step at the time.
- Reaching the bottom of the stair, put the front castors safely down on the floor.

-  **Turn the anti-tip downwards.**

-  **If two companions are present, one person can assist lifting in the front of the frame.**

-  **Do not lift the wheelchair holding onto the leg supports.**

-  **Do not lift the wheelchair holding onto the arm supports.**

8.7 TRANSFER

Techniques for transferring to / from the wheelchair should be practiced well with the persons involved. Here, we give some important advices for preparation of the chair:

With or without companion – sideways.

Before transfer:

- The wheelchair should be placed as close as possible to the destination of the transfer.
- Pull the wheelchair backwards 50 – 100 mm in order to make the front castors turn forward.
- Lock the brakes.
- Tilt chair to horizontal position.
- Remove leg support and arm support on the side of the transfer.

With or without companion – forwards.

Before transfer:

- The wheelchair should be placed as close as possible to the destination of the transfer.
- Pull the wheelchair backwards 50 – 100 mm in order to make the front castors turn forward.
- Lock the brakes.
- Tilt chair forward.



Using a lift.

Before transfer to chair:

- Tilt the chair back.
- Remove the head support.
- Remove the leg supports.
- Open the backrest angle slightly.
- Replace the components when transfer is finished.





-  Never stand on the foot plates due to the risk of tipping the chair forwards.

8.8 LIFTING THE WHEELCHAIR

The wheelchair should be lifted by the frame, and push bow only.

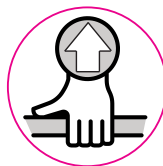
Lifting labels show where to hold.



-  Never lift the wheelchair by the leg supports or arm supports.
-  Do not lift the wheelchair with a user in it.

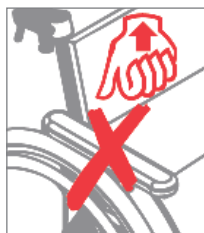



8.9 PUSH RIM

Netti 4U CE PLUS / CES PLUS is delivered with aluminum push rings as standard. The material and distance to the main wheels influences the ability of the user to grip.

Contact your dealer to get information about alternative push rims that fit your chair.



- 

Alternative push rims may give a better grip, but the friction may increase. When using the hands to stop the chair, the risk for burning of the hands increases.
- 

A squeezing and trapping hazard of the fingers may occur when passing through narrow passages and if the fingers come between the spokes. To avoid this risk, we recommend spoke protectors as accessory.
- 

If you want / need to change push rims or increase / decrease the distance between the push rims and the wheel, please contact your dealer.

9. TRANSPORT

 Whenever possible transfer to a car seat with vehicle safety belts when you are travelling with a car. Secure the wheelchair or store it in the cargo area of the car.

If you cannot sit in a car seat, please be aware that Netti 4U CE Plus is tested and approved to crash test ISO 7176-19:2008.

Max user weight when use as a seat in a car is 135 kg.

 **Please study the User manual UM0131 – How to use a Netti wheelchair as seat in a car, where even more details are available**

9.1 TRANSPORT IN CAR

When Netti 4U CE PLUS / CES PLUS is used as a seat in a car, all accessory parts that may detach in a crash has to be removed and secured in a suitable location like a trunk.

 **Always use an approve wheelchair and occupant restraint system (ISO 10452:2012) for fixing the wheelchair in the vehicle.**

Netti 4U CE PLUS / CES PLUS has been successfully tested according to the requirement of ISO 7176-19 using a combined wheelchair and occupant restraint system W120/DISR developed by Unwin Safety Systems. For further information: www.Wheelchair securement systems for vehicles | BraunAbility Europe

WHEELCHAIR SECURING

The chair ist marked with stickers showing where to fix the straps.



In front: Use hook or strap attachment.



In the rear: Mount “eye-bolts” – item number 21074 – in one of the holes in the main wheel frame bracket, one by each main wheel.

Hook on a hook / carabine hook in the “eye-bolt”. The angle of the straps should be close to 45°.



- REMOVE accessories**
Netti 4U CE PLUS has been crash tested without any power kit etc. If, at a later point of time a power kit, stair climber etc. is mounted, you need to check if your power assistant device is crash tested and approved for wheelchairs being used as seat in car. If not, this must be dismantled – and secured elsewhere, when the wheelchair is used as a seat in a vehicle.

SECURING THE USER

Netti 4U CE PLUS has been successfully tested in a forward facing orientation with both pelvic and shoulder belts, according to the requirement of ISO 7176-19 using a combined wheelchair and occupant restraint system W120/DISR developed by Unwin Safety Systems. For further information: www.Wheelchair securement systems for vehicles | BraunAbility Europe

- SECURING THE USER – Always use the occupant restraint belts in the car for the wheelchair user. The corrective harnesses used in a wheelchair are not safety belts.**
- Always use both pelvic and shoulder restraints to reduce the possibility of head and chest impact with vehicle components.**
- Make sure that the 3 point safety belt lays tightly across the body of the user and not across arm supports, wheels etc.**

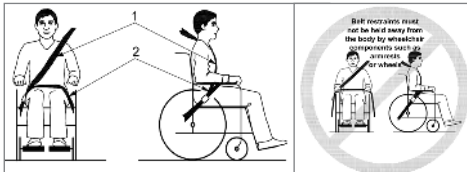

- Make sure that the seat belt webbing is not twisted and that the seat belt buckle and its release button is positioned so that it will not be contacted by wheelchair components during crash.**

If the head support is mounted correctly it is very stable but does not replace the need for an external neck support mounted in the car.

- For users taller than 1.85 m, install backrest extender when the chair is being used as a seat in a vehicle.**
- Always use Netti Cushions when the wheelchair is used as a seat in a vehicle.**
- Never use the wheelchair as a seat in a car after it has been in an accident with impact, before it has been inspected and approved for this by the manufacturer's representative.**
- Never do alterations or substitutions to wheelchair securement points or structural and frame parts or components without consulting the manufacturer.**
- For more details see UM0131. How to use a Netti wheelchair as a seat in a car.**
- Please be aware that wider wheelchairs have bigger turning radius and reduced manoeuvrability in vehicles. Smaller wheelchairs generally provide greater ease of vehicle access and manoeuvrability to a forward facing position.**

The rating of the wheelchair's accommodation of vehicle-anchored belt restrains is **A= good**.

9.2 FOLDING FOR TRANSPORT

When the wheelchair is unoccupied, fold it as described below. Put the wheelchair in the trunk or back seat. When placed in the back seat, secure all parts and the frame using safety belts.

- Remove the head support (Chapt. 6.10).
- Turn the anti-tips upwards (Chapt. 6.7).
- Remove the arm supports (Chapt. 6.11).
- Remove the leg supports (Chapt. 6.9).
- Pull out the locking bolt for the backrest, and place the backrest forward in the seat (Chapt. 6.5).
- Remove the main wheels (Chapt. 6.2).
- Remove the front castors (Chapt. 6.3).

9.3 TRANSPORT IN AIRPLANE

Netti 4U CE PLUS and CES PLUS wheelchairs may be transported in airplane without any restrictions. Netti 4U CE PLUS and CES PLUS wheelchairs are equipped with 2 gas springs. These are however not classified as dangerous goods.

Contrary to general dangerous goods instruction UN3164, the IATA-DGR (special regulation A114) rules that the goods that contain gas and are determined to function as shock absorbers (including energy-absorbing devices or pneumatic springs) are NOT subject to the transport instructions i.e. they are indemnified from the following requirements:

- a) Each article has a gas volume which does not exceed 1,6 l and a charge pressure not exceeding 250 bar, where the product of the capacity expressed in liters and charge pressure expressed in bars doesn't not exceed 80.
- b) Each article has a minimum burst pressure of 4 times the charge pressure at +20 degree Celsius for products not exceeding 0,5 l gas space capacity.
- c) Each article is made of material that will not fragment.
- d) Each article was manufactured in accordance to quality standard which is approved by the responsible national authority.
- e) It is proven and shown that the article relieves its pressure by means of a fire degradable seal or other pressure relief device such that the article will not fragment and the article does not rocket.

9.4 TRAVELING ON PUBLIC TRANSPORT

The wheelchair should be put in a special area for wheelchairs. The wheelchair should face opposite the direction of travel. The back of the wheelchair must be located against a fixed object such as a row of seats or a partition. Make sure the user can easily reach any hand rails or handles.

10. MAINTENANCE

10.1 MAINTENANCE INSTRUCTIONS

 You as a user of the wheelchair (and your attendants and family) are responsible for the everyday maintenance of the chair. Clean it regularly. Do the maintenance to assure safe and long time reliable functions and hygienic appearance.

Frequency	Weekly	Monthly
Check defects / damages e. g. breakage / missing parts	X	
Washing of wheelchair		X
Oiling of bearings with bicycle oil*		X
Washing of cushions		X
Check anti-tip function		X
Check brake adjustment		X
Check function of QR-axles – see chapter 6.2		X
Check tyre wear		X

10.2 CLEANING AND WASHING

1. Remove cushions before washing the wheelchair.
2. Clean the frame using water and a rag.
3. We recommend using soft soap.
4. Rinse the wheelchair well using clean water to remove all the soap.
5. Use methylate spirit to remove any dirt left.
6. Clean cushions and covers according to instructions printed on cushions.

NETTI CUSHION CLEANING PROCEDURES

CORE	
Washing	Hand wash 40° C
Disinfection	Virkon S
	Auto clave 105° C
Drying	Squeeze
	Air dry standing edgewise
OUTER COVER	
Washing	Machine wash 60° C
Drying	Tumble dry max. 85° C

DISINFECTION OF THE WHEELCHAIR

Remove cushions.
See separate washing instruction above:
Wipe disinfection: use a soft rag wetted with Hydrogen peroxide or technical alcohol (isopropanol) and wipe the whole chair clean. Hydrogen peroxide recommended: NU-CIDEX "Johnsen and Johnsen".

 **Check / re-adjust screws and nuts at regular intervals.**

 **Sand and sea water (salt used for gritting in the winter) can damage the bearings of the front castors and main wheels. Clean the wheelchair thoroughly after use.**

* As a rule of thumb, use oil on movable parts and all bearings. Alu Rehab recommends use of ordinary bicycle oil.

SPARE PARTS

The Netti chairs are built of modules. Alu Rehab carries stock of all parts and is ready to supply these on short notice. Necessary instructions for mounting will follow the parts.

Parts to be handled by user are defined in spare part catalogues that can be downloaded at www.My-Netti.com.

These parts can, if needed, also be removed and sent to manufacturer / distributor upon request.

 **Parts related to wheelchair frame construction must be handled by manufacturer or authorized service facility.**

 **If defects or damages occur, please contact your dealer.**

 **Original paint for repair of scratched, can be ordered from Alu Rehab.**

10.3 LONG TERM STORAGE

If the wheelchair is stored for longer time – (longer than 4 months) no particular actions are needed. We recommend that the chair is cleaned before it is stored. Before starting using it again, the maintenance instructions must be followed.

11. TABLE VITAL MEASURES

Netti 4U comfort	CE PLUS	CE PLUS	CES PLUS	CES PLUS
Specification	min.	max.	min.	max.
Overall length with leg support / without leg support	1160 mm / 960 mm	–	1050 mm / 950 mm	–
Overall width	530 mm	680 mm	530 mm	680 mm
Height without headrest	1100 mm	1100 mm	1100 mm	1100 mm
Folded length	660 mm	–	610 mm	–
Folded width	630 mm	–	630 mm	–
Folded width – ex wheels	470 mm	620 mm	470 mm	620 mm
Folded height – ex wheels	600 mm	–	600 mm	–
Total mass	29,0 kg	–	27,0 kg	–
Mass heaviest part – frame	18,5 kg	–	18,5 kg	–
Static stability uphill	0	28°	0	28°
Seat plane angle	–5°	20°	–5°	20°
Effective seat depth	425 mm	500 mm	375 mm	450 mm
Effective seat width	350 mm	500 mm	350 mm	500 mm
Seat surface height at front	465 mm	500 mm	465 mm	500 mm
Backrest angle	90°	–135°	90°	–135°
Backrest height	500 mm	–	500 mm	–
Foot plate to seat distance	280 mm	560 mm	280 mm	560 mm
Leg to seat surface angle	105°	182°	105°	182°
Arm support to seat distance	270 mm	360 mm	270 mm	360 mm
Front location of arm support structure	395 mm	395 mm	395 mm	395 mm
Push rim diameter	535 mm	–	535 mm	–
Horizontal axle location	–50 mm	25 mm	–50 mm	25 mm
Parking brake safe slope	0	7°	0	7°
Minimum turning radius, vertical leg supports	810 mm	–	810 mm	–

Measures CE PLUS model: Seat width 500 mm. Measured without cushions.

Measures CES PLUS model: Seat width 350 mm. Measured without cushions.

12. TROUBLESHOOTING

Symptom	Reason / Action	Reference in manual
The wheelchair is going askew	<ul style="list-style-type: none"> The main wheel hubs might be incorrectly mounted. One of the brakes might be too tight. The user is sitting very askew in the chair. The user might be stronger on one side than the other. 	6.2 6.13
The wheelchair is heavy to manoeuvre	<ul style="list-style-type: none"> The main wheel hubs might be incorrectly mounted. Clean the front castors and forks for dirt. Too much weight over the front castors. 	6.2
The wheelchair is hard to turn	<ul style="list-style-type: none"> Check that the front castors are not fixed too hard. Clean the front castors and forks for dirt. Check, that the front castors are placed in correct position. Too much weight over the front castors, adjust the balance of the chair. 	6.3 6.3
The main wheels are difficult to take off and put on	<ul style="list-style-type: none"> Clean and grease the quick release. Adjust the hub bushing further out from the frame. 	6.2 6.4
The brakes are not functioning well	<ul style="list-style-type: none"> Check the distance between wheels and brakes. Adjust the brake. 	6.13
The front castors wobble and the wheelchair feels "shaky"	<ul style="list-style-type: none"> The front forks are not properly fixed. Adjust the front fork angle. Too much load over the front castors will provoke wobbling, adjust the balance of the chair. Tighten all screws. 	

 Please contact your dealer for information about authorized service facilities that can give support if solution is not reached in this form.

 When in need of spare parts, please contact your dealer.

 When making changes affecting frame construction, contact dealer / manufacturer for confirmation.

13. TESTS & WARRANTY

13.1 TESTS

Netti 4U CE PLUS / CES PLUS are tested and have been approved for usage both indoors and outdoors. The chair is CE marked.

Maximum user weight: 135 kg.

It is tested by
TÜV SÜD Product Service GmbH
according to DIN EN 12183: 2014.



The chair is crash tested at TASS International, Netherlands according to ISO 7176-19:2008.

Seating system is tested for fire resistance according to EN 1021-2:2014.

 When mounting accessories such as power kit etc., the weight of the accessories must be subtracted from the max user weight.

 Specifications varies between countries.

13.2 WARRANTY

Alu Rehab is providing you with a 5-year warranty on all frame components and on the cross-tube assembly. There is a 2-year warranty on all other CE labelled components except for batteries. For batteries a 6-month warranty is provided.

 **Alu Rehab is not responsible for any damage resulting from inappropriate or unprofessional installation and / or repairs, neglect, wear from changes in wheelchair assemblies or institutions not approved by Alu Rehab or by use of spare parts delivered or produced by third parties. In such cases, this warranty shall be considered null and void.**

 **This warranty is only valid when the user use, maintain and handle the wheelchair as described in the user manual.**

13.3 CLAIM

If a product has developed a fault during the warranty period as result of a defect in design or manufacturing, you may forward a warranty claim.

- Claims are to be forwarded as soon as a defect is discovered and not later than 2 weeks after the defect is discovered.
- Claims are to be addressed to the sales agent of the wheelchair. Please note that sales documentation has to be filled in and signed correctly with serial number and eventually NeC number in order to document time and place of the purchase of the wheelchair.
- The sales agent and Alu Rehab are to decide whether a defect is covered by the warranty. The claimer will be informed about the decision as soon as possible.
- If the claim is accepted, the sales agent and Alu Rehab representative are to decide if the product will be repaired, replaced or the customer is entitled to a reduced price.
- If a warranty claim is judged to be invalid – after careful inspection of the defect (defect due to wrong use and / or lack of required maintenance) you are free to decide if you want to have the defect product repaired (if possible) at your expense, or if you want to purchase a new product.



Normal wear, incorrect use or incorrect handling is not a reason for claims.



The user is responsible for the use, maintenance and handling of the wheelchair as described in the user manual if claims are to be accepted.

13.4 NETTI CUSTOMIZED / INDIVIDUAL ADAPTATIONS

Netti customized / individual adaptations are defined as all adjustments that are not included in this manual. Individual adaptations made by Alu Rehab are labelled with a unique NeC number for identification.

Wheelchairs that are especially adjusted /adapted by the customer cannot keep the CE mark given by Alu Rehab A.S Norway.

If the adjustments are performed by other than Alu Rehab approved dealers, the warranty given by Alu Rehab A.S Norway will not be valid.

If there are any uncertainty about special fitting and adaptations, please contact Alu Rehab A.S.



If you have different needs than what our standard wheelchair program can cover, please take contact with customer service for eventually special adjustments or individual solutions.

13.5 COMBINATIONS WITH OTHER PRODUCTS

Combinations of Netti and other products not manufactured by Alu Rehab A.S; generally, in these cases, the CE mark of all the products involved will not be valid.

However, Alu Rehab A.S has made agreements with some manufacturers about some combinations. By these combinations the CE mark and guarantees are valid.

-  For further information, please contact your dealer or Alu Rehab A.S Norway directly.







PRODUCT RESPONSIBILITY

Netti 4U CE PLUS / CES PLUS with different configurations of Netti equipment has been tested / risk evaluated by Alu Rehab.

Any alterations or substitutions must not be made to the wheelchair securement points or to structural and frame parts without consulting the wheelchair manufacturer Alu Rehab.

Substitutions or alterations of components from third part suppliers to Netti 4U CE PLUS requires the risk evaluation and acceptance of the product responsibility and safety for use of the wheelchair from the manufacturer that is performing the substitution or alteration.

13.6 SERVICE AND REPAIR

-  Information about service and repair services in your area, please contact your local dealer.
-  A unique identification number / serial number is to be found on the wheel frame on left side of the chair.
-  A spare part catalogue for the wheelchair can be obtained through your local dealer or downloaded at www.My-Netti.com
-  A refurbishment manual for the wheelchair can be obtained through your local dealer or downloaded at www.My-Netti.com
-  Information about product safety and eventually recalls are found on our home page [www. My-Netti.com](http://www.My-Netti.com)
-  A recycling manual for the wheelchair can be obtained through your local dealer or downloaded at www.My-Netti.com

14. MEASUREMENTS & WEIGHT

	Seat width*	Seat depth**	Backrest height ***	Total width	Transport width	Weight
CES PLUS	350 mm	375 – 450 mm	500 mm	530 mm	480 mm	27,0 kg
CES PLUS	400 mm	375 – 450 mm	500 mm	580 mm	530 mm	27,5 kg
CES PLUS	450 mm	375 – 450 mm	500 mm	630 mm	580 mm	28,0 kg
CES PLUS	500 mm	375 – 450 mm	500 mm	680 mm	630 mm	28,5 kg
CE PLUS	350 mm	425 – 500 mm	500 mm	530 mm	480 mm	27,5 kg
CE PLUS	400 mm	425 – 500 mm	500 mm	580 mm	530 mm	28,0 kg
CE PLUS	450 mm	425 – 500 mm	500 mm	630 mm	580 mm	28,5 kg
CE PLUS	500 mm	425 – 500 mm	500 mm	680 mm	630 mm	29,0 kg

- * Measured between skirt guards.
- ** Measured from front of seat plate to backrest hinge.
Seat depth adjustable by 25 mm per step.
500 mm is standard seat depth.
- *** Measured from the seat plate to top backrest.



The weight is including main wheels, front castors, leg supports and arm supports. No cushions.



Max user weight is 135 kg.



When mounting accessories such as power kit etc., the weight of the accessories must be subtracted from the max user weight.



Luggage loaded on to the wheelchair must not exceed 10 kg.
The luggage must not be placed in a manner that reduce the stability of the chair.



Recommended inflation pressure using air tyres is: 45 PSI - main wheels, 36 PSI - front castors.



Manufacturer:

Alu Rehab AS
Bedriftsvegen 23
N-4353 Klepp Stasjon
Norway



post@My-Netti.com
T: +47 51 78 62 20
my-netti.no

Distributor



Alu Rehab ApS
Kløftehøj 8
DK-8680 Ry
Denmark



info@my-netti.com
T: +45 87 88 73 00
F: +45 87 88 73 19
my-netti.dk

Distributor

Meyra GmbH
Meyra-Ring 2
D-32689 Kalletal
Germany

info@my-netti.com
T: +49 5733 922 311
F: +49 5733 922 9311
my-netti.de

Distributor

MDH Sp. zo.o.
ul. W. Tymienieckiego 22/24
90-349 Łódź
Poland

biuro@mdh.pl
T: +48 42 674 83 84
my-netti.com
