

SileoAged Care Bed

USER GUIDE





Overview

Built for reliable performance and optimum safety for both patient and caregiver, this fully featured electric high-low bed can be easily adapted to suit the specific needs of every patient.

The bed operates as both a high-low bed or four part profiling bed, with electric adjustable bed height, back rest, knee bend and heel lift with extended foot elevation. The scissor lift mechanism ensures smooth, vertical movement of the platform. The sturdy frame is made from powder coated steel while the slatted platform surface to promotes the circulation of air in and around the mattress.

Removable head and foot panels maximise versatility and facilitate cleaning.

Standard Features

- ⦿ high-low functionality
- ⦿ 4 part profiling with optional increased foot elevation
- ⦿ easy to use soft touch electric hand controller with lock-out function
- ⦿ central locking brake system
- ⦿ removable head and foot panels
- ⦿ inbuilt bed extension
- ⦿ mattress retainers to prevent mattress sliding
- ⦿ self help pole mounting bracketing
- ⦿ powder coated surfaces for maximum
- ⦿ durability and corrosion resistance

Optional Accessories

- ⦿ Side Rails (pair)
- ⦿ Self Help Pole
- ⦿ Back Up Battery

Novis Healthcare has a policy of continuous product improvement and reserves the right to amend specifications presented in this guide. Information correct at time of production (November 2016) .







© 2016 Novis Healthcare. All rights reserved.

Important Notice

Before operating this medical equipment, it is important to read this manual and understand the operating instructions and safety precautions. Failure to do so could result in patient injury and/or damage to the product.

Therapeutic devices and/or medical equipment should only be used in accordance with manufacturer's instructions and under the consent, supervision and management of a suitably qualified health professional.

Definitions of Symbols Used

-  Important information
-  Caution
-  Electrical hazard
-  Infection control
-  Do not...
-  Class II equipment
-  Type B Applied part

Overview	2
Safety Precautions	4
Layout	6
Set Up	7
Operation	9
Accessories	1
Troubleshooting	2
Cleaning	1
Maintenance	3
Specifications	1
Warranty Statement	4



1
5
1
6
1
8



Safety Precautions

Conditions of Use

The bed may be used in an indoor environment where the:

- surrounding temperature range is from + 10°C to + 40°C
 - relative humidity range is from 30% to 75%
 - atmospheric pressure range is from 700 hPa to 1060 hPa
-  The bed is designed for use in rooms for medical purposes. Electrical installations must therefore meet local standards laying down the necessary conditions for electrical installations.

In spite of this it is recommended to disconnect the bed from the mains during exceptional situations (ie severe electrical storm).

Safe Working Load

The Sileo Aged Care Bed is approved for a maximum safe working load (SWL) of 220 kilograms, including patient, mattress and bedding, and all bed accessories. Do not exceed this safe working load or you risk injury to the patient or carer, or damage to the product.

-  A maximum patient weight of 185 kilograms is typically recommended, to allow for bed accessories and bedding.

Safety Warnings

 DO NOT attempt to use this bed as a patient transport device.

 Ensure bed castors are locked when nursing or positioning a patient.

 Ensure patient is comfortable and not at risk of injury before activating the actuators and profiling the bed. If entrapment is a risk then bed is best left in a flat position.

 Bed is best left in lowest position whilst patient is unattended to minimise risk of injury through falls.

 Ensure all parts of a patient's body are kept away from all moving parts of the bed frame.

 It is the responsibility of the caregiver to take the necessary precautions to ensure the safety of the patient. This includes, but is not limited to, the appropriate use of side rails to prevent falls and/or patient entrapment.

 Ensure that bed frames and parts are kept clean at all times. Wipe down with an antibacterial solution to avoid risk of patient contamination from any bacterial buildup on bed components.

 The bed's frame supports a mattress with maximum dimensions*:
Standard: 900 mm wide and 2200 mm long
King: 1070 wide and 2200 mm long

* When bed fully extended

 Placing an incorrectly sized mattress on the bed frame will interfere in the operation of the bed and/or may result in patient injury.

 Only plug into a grounded power receptacle and ensure there is no damage to power cord or attachment to the main actuator.

 Exposure of electronic components to any liquid may result in a severe electrical hazard.

 Disconnect the mains cord from the supply before moving the bed.

 Ensure the mains cord is kept clear of the wheels when moving the bed, and is never caught in the bed operating mechanism or in a side rail. It can be dangerous to run over the mains cord.

 Ensure the mains cord has enough slack when connected that it is not strained when the bed is raised and lowered.

 The actuators are precision electronic products. Use care when handling or transporting. Dropping, or other sudden impacts, may result in damage to these units.

 Risk of electric shock. DO NOT OPEN. Do not attempt to repair or service the actuators. Repairs and service should be conducted by an authorised Novis Healthcare Service Centre or trained technician.

If the actuators are not functioning properly, or have been damaged, unplug the unit and take it out of service immediately. Contact Novis Healthcare or authorised dealer for repair and service information.

 Do not place any objects/items, such as blankets, on or over the actuator arms or joints. This could result in damage.

 The power cord to control box under the bed should be positioned to avoid a tripping hazard and/or damage to the cord.

Novis Healthcare recommends securing the cord under the bed frame using the cable clips provided, and attaching it to an electrical outlet by the head of the bed.



Layout



* Optional accessory

Unpacking

The Sileo Aged Care Bed is shipped as a fully assembled item; the only assembly required before use is insertion of the head and foot panels.





Prior to use, ensure any excess packaging is removed and carefully check the bed for any damage that may have occurred in transit, paying particular attention to:

- any damage to the bed frame
- any damage to the head or foot panels
- any damage to the castors
- any damage to the power cord



 We recommend the bed frame is cleaned and disinfected before use.

 Please follow the cleaning instructions on page 14.

Preliminary Set Up

- 1 Move the bed into the proposed position.
 - Leave a minimum 50 mm gap between the head of the bed and the wall or other equipment, to ensure the bed does not collide with wall or equipment when raised or lowered.
- 2 Connect the power cord to a grounded power outlet (240V) and switch on.
 -  Take up any excessive power cord supply and secure excess cord under the bed frame, using the cable clips provided.
 -  Ensure the cord has sufficient slack when connected so that it is not stretched when the bed is operated or moved.
 -  Keep the cord away from the castors or any moving parts.
- 3 Check all four Mattress Retainers are securely inserted into the corresponding slots on the bed frame. Securely reinsert as needed.
- 4 Ensure head and foot panels are securely mounted (see page 8).
- 5 Check the cotter pin (that locks the actuator to the backrest bed frame panel) is securely fastened. 
- 6 Place mattress on the bed. **COTTER PIN**

Attention

-  If the mattress uses straps to secure the mattress to the bed frame, ensure straps are placed underneath the moving sections to ensure correct operation of the bed is not impacted. Failure to do so could cause damage to the mattress or the bed.
-  When raising or lowering the bed, ensure that no person or any part of a person is under the bed. Failure to do so could result in serious injuries. Keep limbs clear of all moving parts of bed during operation.

Head and Foot Panels

- 1 Ensure mains power is switched on.
- 2 Raise the bed to full height by pressing the 'Bed Up' symbol on the Hand Controller.

- 3 To mount the head panel (larger board), release the two locks on the inside of the panel.

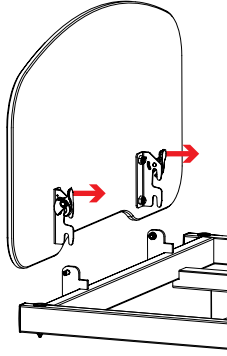

- 4 With locks facing inwards, hook the top clip on each side of the panel into the corresponding holes on the bed frame.

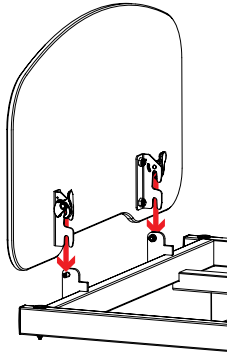

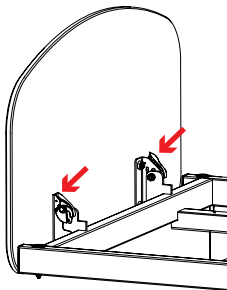

- 5 Once secure, push down hard on each lock until an audible click is heard, and the locking mechanism is secure.



- 6 Repeat for foot panel (smaller board) at the foot end of the frame.

 To remove head and foot panels, release the locks and remove each panel carefully.

Castors and Brakes

-  It is recommended that shoes be worn to operate the locking bar.
-  Castors must be locked before repositioning the bed or during patient transfer.
-  It is recommended that the castor lock is applied whenever the bed is in use.

The bed is fitted with a central locking brake system, activated by the foot operated locking bar located at the foot end of the bed.



To activate the central lock, step firmly on the locking bar.

To release, place foot underneath the bar and lift upwards.

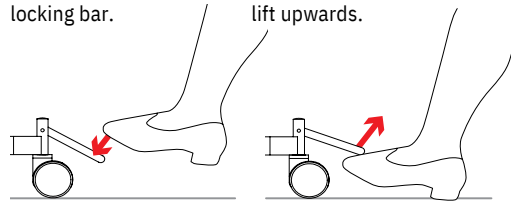



To Operate the Hand Controller with Lockout

When using the Hand Controller with Lockout function, the handset must be activated before use. The Hand Controller has a magnetic tamper proof lock. The magnetic key is located on the cord just below the control pad.

Before use, ensure there is

power to the system – the power light at the base of the controller will

⚠ glow. The magnetic key should remain in a safe and secure location if the patient is deemed incapable of operating the bed.

⚠ Whenever electricity supply is disconnected, the Function Lock automatically engages rendering all functions inactive. To re-enable the functions swipe the magnetic key past the lock symbol.

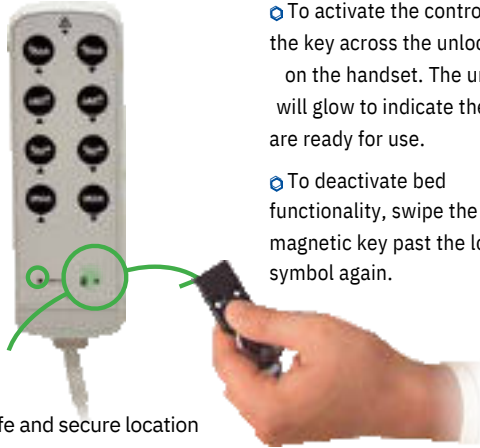

⦿ To activate the controller, wave the key across the unlock symbol on the handset. The unlock light will glow to indicate the controls are ready for use.

⦿ To deactivate bed functionality, swipe the magnetic key past the lock symbol again.

To operate the bed, press and hold the relevant button on the Hand Controller.

Upper body incline/decline

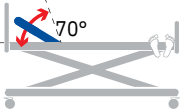

Synchronous upper and lower body incline/decline (Auto Contour)

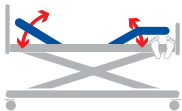

⚠ When raising or lowering the bed, ensure that no person or any part of a person is under the bed. Failure to do so could result in serious injuries.

⚠ Keep limbs clear of all moving parts of bed during operation.

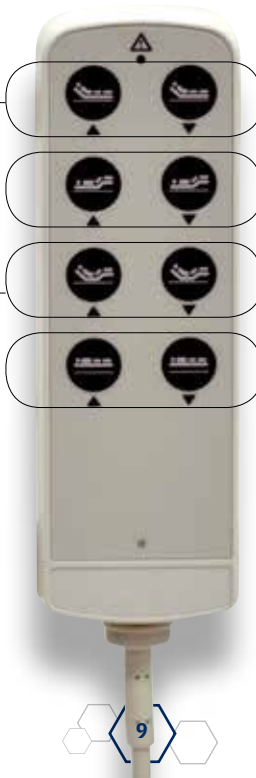

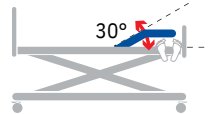

Lower body incline/decline

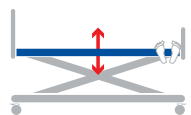

Bed raise or lower



Base Extension

-  It is recommended that the bed platform be extended before placing the mattress on the bed. For caregiver safety, do not operate the extension with a patient lying on the mattress.
-  To extend the length of the platform, loosen the extension locking knob located underneath the bed platform, in the centre of the bed. Pull the extension frame outwards to the desired length. Maximum extension range is 200 mm.
-  Re-tighten the extension locking knob to lock the extension at the desired length. Ensure this lock is secure before use.

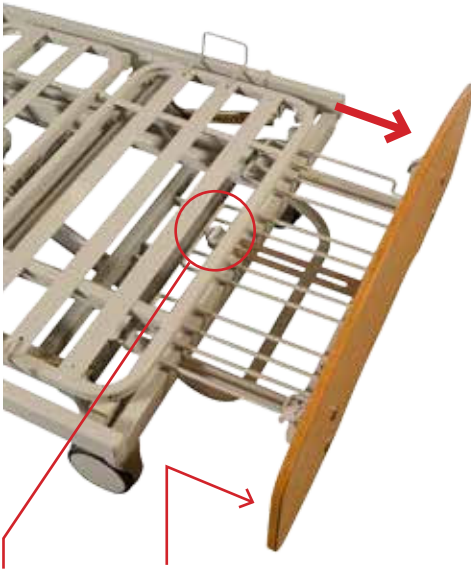

- 1** Loosen the extension knob
- 2** Pull frame outward
- 3** Re-tighten the extension knob.

Mattress Retainers (Set of 4)

Four removable Mattress Retainers are included standard with the bed.

They are inserted into the bed frame to secure the mattress and stop it from sliding.



Remove the mattress from the bed. Slide each retainer into the corresponding slots in the bed base, each positioned approximately 300 mm from the head and foot panels.

-  Ensure they are correctly positioned before replacing the mattress.

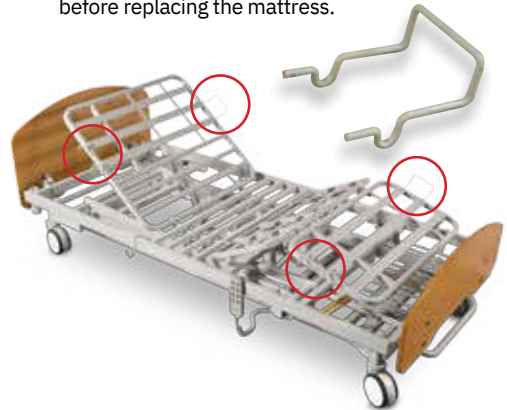

Drainage Bag Holder

A drainage bag holder is included standard with the bed. Clip the holder over the edge of the bed frame in the desired position. Un-clip and store when not in use.



⚠ When using side rails, the drainage bag holder must be placed with the hook on the inside of the bed frame, to ensure it does not interfere with the safe operation of the side rails.

Heel Lift – Extended Foot Elevation

Once the knee break and heel lift sections are fully inclined, the feet can be further extended by manually raising the heel platform.

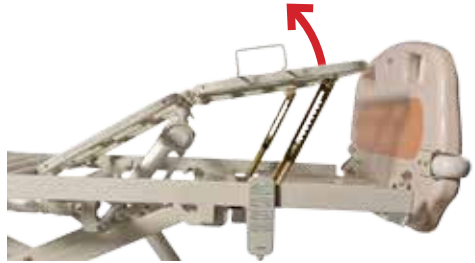

To lower, lift the platform upwards to disengage the ratchet lock and lower gently.

⚠ The foot elevation must be manually lowered before attempting to recline the bed frame to the flat position.

Failure to lower the foot extension may cause injury to the patient or the bed frame.

Back Up Battery (optional)

Rechargeable battery pack for a single operation, in the event of a power failure.

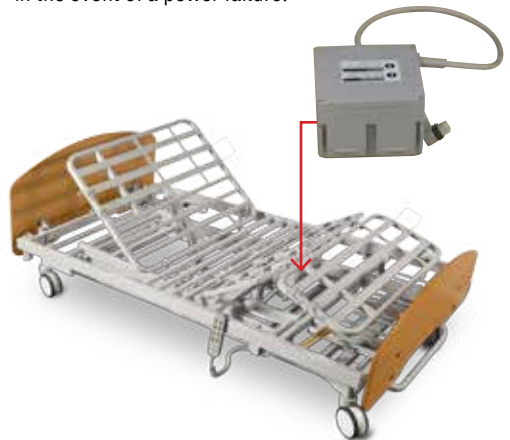



Accessories

Head / Foot Panel



STANDARD KING		
Golden Oak	Head Panel	BE0011 BE0021
	Foot Panel	BE0012 BE0022

 To mount head and foot panels, refer to the instructions on page 8.

Collapsible Side Rails



Collapsible metal side rail system attaches securely to bed frame.

Easy to raise and lower.

Please ensure compliance with local regulations regarding side rails as a form of restraint. Minimum height from top of mattress to top of rail must be 220 mm.

BE6001

Self Help Pole



Support pole to aid patient repositioning while lying in bed. Pole can be inserted into the round hole at either side of the head end of the bed.

The Self Help Pole has a notch to prevent the pole from swinging sideways during transfer.

BE7001

Back Up Battery



A rechargeable battery pack designed for a single operation, in the event of a power failure.

Pack plugs into the Control Box and attaches to a cradle mounted underneath the bed frame.

BE5001



PROBLEM	CAUSE	SOLUTION
Hand Controller inactive	AC power failure	1 Check the power cord is firmly plugged into the mains outlet and the control unit; and check the mains power is switched on.
		2 Check both the actuator and hand controller cables are firmly fitted into the main actuator control box under the bed base.
		3 Check for any damage to or disconnection of any of the actuator power or hand controller cables.
	Magnetic lock active	1 Swipe the magnetic key over the unlock symbol on the front of the handset – the light should activate 2 Ensure the flat base of the key is pointed towards the symbol 3 Ensure main actuator connections are inserted properly and are vertically aligned
	Actuator system fault	1 Check inside each connector to ensure that the pins are not bent or damaged 2 Check that each connector is in its correct plug – this is clearly marked. 3 Check if central locking system is activated; place foot underneath locking bar and lift up to release.
Castors not rolling	Castors locked	1

If the problem cannot be resolved, please contact Novis Healthcare or your authorised Service Centre for further support.



Cleaning

- ⚡ Switch off mains power and disconnect the power cord from the electrical outlet before cleaning
- ⚠ Do not use high pressure cleaners, steam cleaners or harsh caustic chemicals for cleaning.
- ⚠ Do not use solvents or alkalines such as cellulose or acetone thinners.
- 🧤 Hand wipe bed frame surfaces with a damp cloth and mild disinfectant hand spray if necessary.
- ⊗ Do not directly spray the bed frame, especially the electrical parts.
- 🕒 Use only officially recognised disinfectants and mild cleaning solutions.
- 🕒 Clean the main actuator unit separately ensuring no excessive amount of moisture is used and no liquids ingress the electronic or actuator openings.
- 🕒 Dry thoroughly before use.



Disassembly and Storage

- 🕒 Remove any accessories (including head and foot panels as required) and lower the bed to the minimum height.
- 🕒 Switch off mains power and disconnect the power cord from the electrical outlet.
- 🕒 Store all items safely together.









For Battery Back Up model

- 🕒 If storing the bed for an extended period of time, disconnect the battery Back Up by removing the power cord from the actuator control box.
- ⚠ Please note, to preserve the life of the Back Up battery, the battery must be charged for at least 10 hours every 4-5 months. Battery will recharge when bed is connected to a mains power source.







-  Annual service and maintenance is required every 12 months as a minimum, and should only be performed by Novis Healthcare or a qualified technician. Contact Novis Healthcare for service support.
-  It is recommended that the following routine inspection and cleaning procedures be conducted between patients or at a minimum every 12 months.
-  Switch off mains power and disconnect all power cables before inspecting the bed.

Visual Inspection – Frame and Accessories

-  Visually inspect all castors to ensure they are free of dirt and debris; and that they roll without restriction. Check to ensure all castors lock when foot brake is activated.
-  Visually inspect the bed frame for damage or excessive wear and tear and check all bed functions are operating correctly
-  Examine all welds for cracks or fatigue.
-  Inspect the powder coating finish to ensure it is intact and no rust spots have developed.
-  Inspect all bolts and screws to ensure they are securely tightened.
-  Inspect the head and foot panels for damage.
-  Inspect the side rails (if in use) to ensure rails move smoothly without restriction; the locking pin releases and connects without aid;
-  and all screws are securely tightened.

Visual Inspection – Actuators, Cables and Hand Controller

-  Check for noise and performance of all motors; ensure all bed functions operate without excessive noise.
-  Visually inspect all power cables for chafing cuts or excessive wear; and ensure cables are free of obstruction and are not strained or pulled tight.
-  Visually inspect all connectors are free of damage and firmly connected.
For Hand Controller with Lockout (optional);
-  ensure the lock out function is working; the activation lights are operational; and the magnetic key is activating and deactivating the lock.
For Back Up Battery (optional), check the
-  battery is sufficiently charged overnight to operate the actuators.



Specifications

Electrical Ratings	Control BoxMain Actuator Australian	Back Rest Actuator	Leg Rest Actuator
VOLTAGE INPUT	– 100-240V AC, 50/60Hz 3.15A		
MAX CURRENT	4.5A	3.5A	3.0A
INPUT VOLTAGE	29V DC24V DC	24V DC	24V DC
OUTPUT DUTY RATING	2 min / 2 min ON / 18 min18 min OFF	2 min ON / 18 min OFF	2 min ON / 18 min OFF
PUSH FORCE	Max 6000N	Max 4000N	Max 4000N
PULL FORCE	Max 6000N	N/A	N/A
PROTECTION CLASS	IPX6 IP54	IP54	IP54
INSULATION CLASS	IIB	B	B

 Double insulated, class II, type B

 Patient not separated from ground or chassis

Weights (kg)	STANDARD	KING
BED WITHOUT HEAD & FOOT PANELS	102	107
ACTUATORS (SET)	6.35	6.35
HEAD PANELS	5.2	7
FOOT PANELS	3.5	5
SIDE RAIL (PAIR)	15	15
SELF HELP POLE	3.65	3.65
BACK UP BATTERY	1.45	1.45

Approvals

COMPLIANCES	IEC60601-1 IEC60601-2-52 IEC 60601-1-2 ISO9001:2008,
MANUFACTURED UNDER	ISO13485:2012, ISO14001:2004
THERAPEUTIC GOODS ADMINISTRATION	Bed: ARTG 278782 Accessories : ARTG 278802



185 kg recommended
maximum patient weight

 SWL 220 kg complete with accessories and bedding

Novis Healthcare reserves the right to alter any product specifications without prior notice.

Novis Healthcare accepts no liability for any use, change or assembly of the product other than as stated in this user guide.

Specifications	STANDARD	KING
SAFE WORKING LOAD	220 kg	220 kg
MAXIMUM PATIENT WEIGHT	185 kg	185 kg
FRAME MATERIAL	Powder Coated Steel	Powder Coated Steel
RECOMMENDED MATTRESS		
DIMENSIONS	W 860 – 900 mm L 1960 - 2200 mm	W 1050 – 1070 mm L 1960 - 2200 mm
BED WITH GOLDEN OAK PANELS		
BED WITH WARM OAK PANELS	BE1001	BE2001
BED WITH MOULDED PANELS	BE1002	BE2002
	BE1003	NA

Dimensions (mm)	STANDARD	KING
A OVERALL LENGTH	2036 \pm – 2236 \pm with bed fully extended	2036 \pm – 2236 \pm with bed fully extended
B SLEEPING PLATFORM	1825 \pm – 2025 \pm with bed fully extended	1825 \pm – 2025 \pm with bed fully extended
OVERALL WIDTH	920 †	1090 †
C OVERALL WIDTH WITH SIDERAILS	1027 †	1197 †
D HEAD PANEL HEIGHT	500	600
E FOOT PANEL HEIGHT	335	370
F CLEARANCE HEIGHT FROM FLOOR	166	166
F HEIGHT (BASE)	330 – 780	330 – 780
G BACKREST SECTION	708	708
H MID SECTION 70° raising	285	285
I UPPER LEG SECTION	405	405
J LOWER LEG SECTION 30° raising	427	427
K 38° lowering		

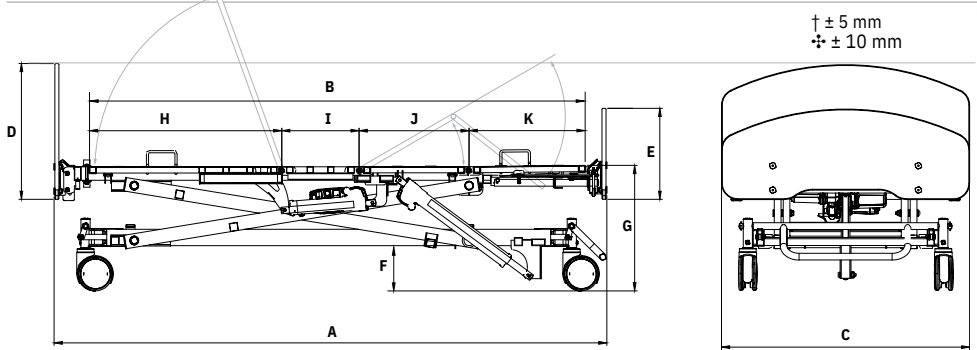



This warranty is provided by

Novis Healthcare (ABN 45 102 735 491)
of Unit 11, 12 Mars Road Lane Cove
2066 New South Wales Australia.



Australian Consumer Law

Our goods come with guarantees that cannot be excluded under the Australian Consumer Law. You are entitled to a replacement or may be entitled to a refund for a major failure and compensation for any other reasonable foreseeable loss or damage. You are also entitled to have the goods repaired or replaced if the goods fail to be acceptable quality and the failure does not amount to a major failure. Where a failure does not amount to a major failure Novis Healthcare is entitled to choose between providing you with a repair, replacement or refund. To obtain compensation, you would need to provide documentary evidence of the loss or damage suffered and documentary evidence that such loss or damage was a reasonable foreseeable consequence of a failure by Novis Healthcare to comply with a consumer guarantee under the Australian Consumer Law.

At our option:

- goods repaired may be replaced by refurbished goods of the same type rather than being repaired
- refurbished parts may be used to repair goods

Product Warranty

In addition to all rights and remedies which you may be entitled to under the Competition and Consumer Act 2010 (Commonwealth) and any other relevant legislation, Novis Healthcare warrants this product to be free of defects in materials and workmanship for the following periods, commencing from the date the product is received by the purchaser:

Frame 10 year

Actuators 3 year

Castors 2 year

Back Up Battery 1 year

Subject to the provisions of the Australian Consumer Law, Novis Healthcare excludes, to the fullest extent permitted by law, all liability in respect of loss of profit or other economic loss, direct or indirect or consequential, special, general or other damages or other expenses or costs which may include negligence.

Warranty Claims

To claim under this warranty, please contact Novis Healthcare and have your receipt or proof of purchase available. Novis Healthcare may need to assess the defect before determining any claim, and additional information may be requested to process your claim.

Any expenses incurred relating to the return of the defective product to Novis Healthcare will be borne by us. We will then, at our discretion, either repair or replace the product, or refund your money and take back the product. Warranty repairs do not extend the length of the warranty period.

Limited Liabilities

Our liability under this manufacturer's warranty is subject to us being satisfied that a defect was caused by faulty parts, manufacture or workmanship, and was not caused or substantially contributed to by other factors or circumstances beyond our control, including (but not limited to) defective installation, maintenance or repair, product modification or alteration, any neglect, misuse, or excessive use, normal wear and tear or failure to follow manufacturer's instructions.

The benefits conferred by this manufacturer's warranty are in addition to all rights and remedies conveyed by the Competition and Consumer Act 2010 (Commonwealth), and any other statutory rights to which you may already be entitled, and this warrant does not exclude, restrict or modify such rights or remedies that are implied by law.

Mail To

Novis Healthcare Service Centre:
Unit 12, 12 Mars Road Lane Cove NSW 2066

For more information please contact us on
1300 738 885, email novis@novis.com.au
or visit www.novis.com.au



**novis**

pressure care and patient handling specialists

novis.com.au / 1300 738 885