

molift[®]

QUICK RAISER



BM04101 - Rev I 20/05/2021

molift[®]
by Etac

OPERATOR MANUAL

Table of content

About Molift Quick Raiser 1, 2 and 2+	2
Molift Quick Raiser - use	3
Check list before use	3
General Safety precautions	4
Adjusting and transferring	5
Assembly and disassembly	7
Battery and charging	9
Safety devices	10
Technical data Molift Quick Raiser 1	11
Technical data Molift Quick Raiser 2	12
Technical data Molift Quick Raiser 2+	13
Labels and symbols	14
Accessories	15
Troubleshooting	16
Warranty notice	16
Maintenance	17
Checklist for periodic inspection	18

About Molift Quick Raiser 1, 2 and 2+

Molift Quick Raiser is designed to cover the need for lift and transfer of patients who are to some extent capable to actively participate in the process. The lifter has an exceptional design and the shape of the lifter and geometry of the lifting movement imitates the natural pattern of movement of a person. The lifter is only intended for lift and transfer to and from a sitting position.

- Molift Quick Raiser 1 has fixed legs, while Molift Quick Raiser 2 / 2+ has spreadable legs.
- Molift Quick Raiser 1 and 2 has a lifting capacity

of 160 kg Safe Working Load (SWL).

- Molift Quick Raiser 2+ has a lifting capacity of 200 kg Safe Working Load (SWL).

All three variants of Molift Quick Raiser is described in this manual, and when Molift Quick Raiser is written it applies for all three, if not it is specified by number 1, 2 or 2+.

	<p>CE declaration</p> <p>The product, and its related accessories, described in this instruction for use (IFU), is in compliance with the regulation (EU) 2017/745 of 5. April 2017 – as a medical device, risk class I. The product is manufactured and tested according to standards IEC 60601-1, IEC 60601-1-2 and EN/ISO 10535:2006. Any serious incident that occurs in relation to the device should be reported to the manufacturer and the competent authority of the Member State in which the user and/or patient is established.</p>
---	---

Before using the patient lifter

Before using a patient lifter, the operator must be trained accordingly. Practice lifting a colleague, and be lifted by others. It is important not only to know how to move another person using the lifter, but also how it is to be lifted. Try out and practice using all the relevant slings for the different types of lifter and movement you may encounter. Before lifting a person, you should explain the procedure. When using the lifter, it's also important to use the correct sling and accessories according to:

- type of disability
- size
- weight
- type of movement



The lifter must be taken out of service immediately, or not returned to service, if faults and/or irregularities that may have influence on the safety are discovered.

Molift Quick Raiser - use

The hand control for Molift Quick Raiser 2 and 2+ has four buttons, two buttons for raising and lowering, and two buttons for adjusting the legs in and out. Molift Quick Raiser 1 has only two buttons for raising and lowering. In addition there is a diode which gives a light when the battery needs charging.



Check list before use

1. Check that the lifter has no visible damages or missing parts.
2. Check that there are no loose parts, verify that the lifting arm and column are properly fastened
3. Check that the emergency stop is not activated and that the lifter is working.
4. Check that the battery is charged (battery lamp gives no light).
5. Check that the service lamp gives a green light. If service lamp gives a yellow or red light, the lifter should be taken out for service.

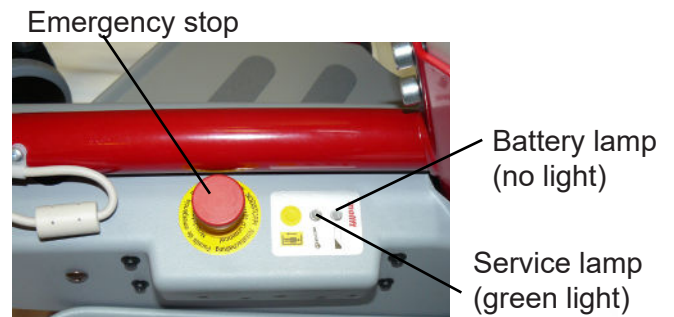

General Safety precautions

Explanation of symbols used in this manual

 This symbol is used to point out instructions and information related to work place safety where injury may occur if the information is disregarded or ignored. Follow these instructions, be careful and attentive at all times.

 This symbol indicates important and useful information. If taken into consideration, it will help the operator of the lifter to work efficiently. It may help simplify routines and to explain complicated facts.

General

Before putting a Molift Quick Raiser into operation, the operator must ensure that the lifter and accessories are in good working order, especially with regards to safety. A Molift Quick Raiser shall only be used when all safety devices and equipment is in place and fully operational. The lifter must be taken out of service immediately, or not returned to service, if faults and/or irregularities that may have influence on the safety are discovered.

 The lifter has an expected lifetime of 10 years or 30 000 lifts with max load (SWL), when all recommended service is performed.

Injury to personnel or equipment may occur if Molift Quick Raiser is used in an incorrect manner and if:

- covers are removed by unauthorised personnel
- used incorrectly
- insufficient maintenance
- load exceeds maximum limit. The SWL stated on the lifter is the maximum load
- unauthorised repair of electrical devices

Lift and transferring

 Molift Quick Raiser 1 and 2 have SWL (Safe Working Load) on 160 kg, meaning that they are tested and approved for lifting patients up to 160 kg. Molift Quick Raiser 2+ has a SWL on 200 kg. Attempts of lifting patients with a higher weight, may lead to danger of personal injury.

 The patient lifter may tip over if used incorrectly! Ignorance of warnings and instructions may lead to personal injury. Read instructions carefully before attempting to lift anyone.

 Pay close attention to your actions. Ensure that both ropes of the sling are securely fastened to avoid the user slipping or falling.

 Use the drive handles when manoeuvring the lifter, do not push or pull the patient or lifting arm.

 Keep fingers, arms or similar away from trolley during use! Danger of clamping between knee support and trolley.

 Torn, cut, frayed or broken slings can fail, resulting in serious injury to the user. Use slings in good condition only. Destroy and discard old, unusable slings

 Molift slings shall ONLY be used to lift persons. NEVER use the sling to lift and/or move objects of any kind.

 - Molift QuickRaiser should not be run constantly for more than 2 minutes (with maximum load), and rest for minimum 18 minutes.

 If the expected movement does not start when the corresponding button is pressed, please consult the fault finding table in the maintenance chapter to locate the fault.

Several factors have to be considered during transferring. Stand to the side of the user when lifting. Ensure that arms and legs are clear of the lift, chair, bed etc. Try to maintain eye contact with the user - this will help the user feel safe and comfortable.

 Medical electrical equipment requires special precautions regarding electromagnetic compatibility (EMC). Portable or mobile radio communication equipment may affect the medical electrical equipment, and should be kept minimum 25 cm (10 inches) from the lifters electronics

Adjusting and transferring

Lifting

- Lower the lifting arm to the lowest position
- Alternatively adjust the legs of the QR2/QR2+ to adapt to the lifting situation

i To perform a comfortable lift for the patient, it is recommended that the patient is sitting in a normal upright position with near 90° in ankles and knees. It is also recommended that the patient is wearing suitable shoes or socks with good friction towards the floor.

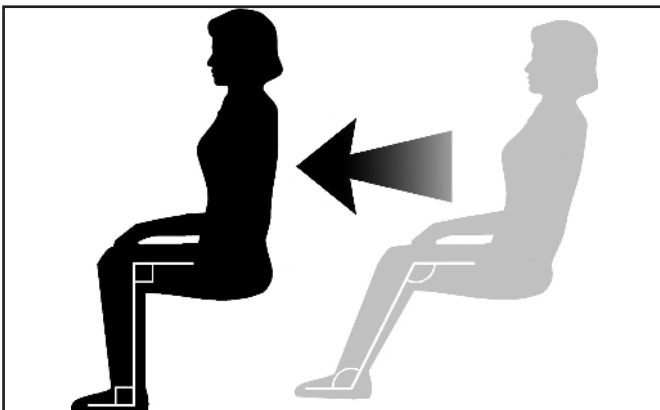

! If the patient is sitting in a wheelchair, it is necessary to put on the wheel chair brakes. It's also recommended to lock the wheels of the Quick Raiser when performing the lift.

! Patients with an extremely high or displaced centre of gravity (i.e. lameness on one side of the body or high weight on the upper body) may cause the lifter to tip over. Such patients should be lifted in a passive lifter, i.e. Molift Partner or Molift Smart, and not with an active lifter like Quick Raiser.

- Place the Molift RgoSling StandUp sling around the back of the patient as far down as possible. Connect the belt and tighten.

! The ropes must be tightened firmly on the lifting arm. The rope will lock itself due to the weight of the patient, but if sliding too much before locking, it may cause an uneven lift and discomfort for the patient. Check that the rope has a knot in the end.

Using a V-shaped arm

- Fasten the sling to the lifting arm by pulling the ropes firmly into the rope locks from the inside and out as shown in the illustration. When lifting the patient, the ropes will lock even tighter due to the weight of the patient. The patient should grab and hold the handlebars of the lifting arm if possible.

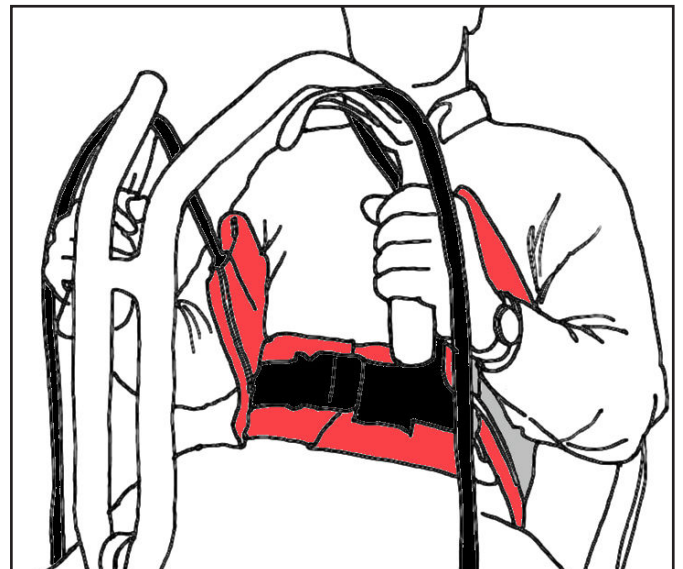

i If the patient is large and heavy, it is recommended to lock the rope from the outside and in to increase the width of the ropes. This will reduce any pinching effect to the patients chest.

Using a U-shaped arm

- On a U-arm the ropes is attached to the lifting arm by pulling them firmly from above into the rope locks as shown on the illustration.

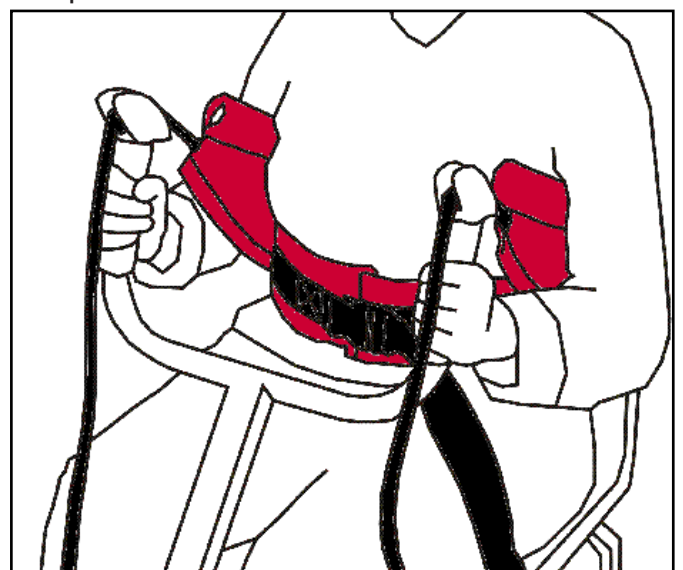

- Move the Quick Raiser in front of the patient and place it in such a way that the patient can place the feet on the footplate on the chassis. If necessary - help the patient placing the feet correctly.

i *The distance from the front edge of the lifter to the kneepads increases when they are moved upwards.*

- Adjust the height of the kneepads so that the top of the pads are approx. two finger widths under the kneecap. Loose the locking wheel on the knee support bracket when adjusting.

i *The scale on the column can be used to note the correct height of the kneepads for different users*

- Attach the strap to the kneepads around the users legs.

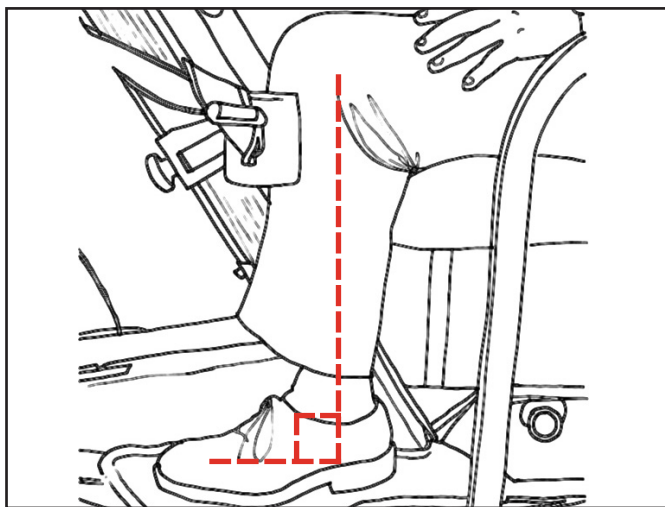

! *If it proves to be impossible to place the leg perpendicular to the footplate, you should pay extra attention when lifting to avoid over stretching the knee joint.*

- Raise the patient carefully until the buttocks are clear from the seating and tighten the belt. Unlock the wheels on the lifter and move the patient to the next location.

Movement

! *The patient should not be standing straight up during movement - this can be experienced as uncomfortable.*

Be careful during movement not to run into furniture, walls, doors etc.

! *The lifter shall not be used to lift or move users on sloping surfaces.*

Avoid deep pile carpets, high thresholds, uneven surfaces or other obstacles that may block the castors. The lifter may become unstable if forced over such obstacles increasing the risk of tipping over. If it is necessary to cross obstacles like a low door sill, make sure to pull the lifter carefully straight over it with the big wheels first.

! *The lifter shall only be used for movement over short distances. It is not a replacement for wheelchair or similar.*

Lowering

- Lower the patient into sitting position at the desired place.

! *If the patient is to be seated into a wheelchair, please observe that the wheel brakes must be locked on the wheelchair when lowering, but NOT on the lifter.*

- Loosen the strap around the users legs and release ropes from locks.
- Remove the lifter and remove the sling.

Assembly and disassembly

Unpacking

- The lifter comes in a cardboard box. Verify that the box has no apparent damage. If damaged, - check the contents and contact your dealer for assistance if components are damaged.
- The box contains as standard a chassis, lifting column, knee support, lifting arm, drive handle, hand control, battery, battery charger, power chord and documentation.

 *Parts from lifters with different lifting capacity must not be used.*

Assembly

 *The battery must not be in the battery holder on the column during assembly!*

- At the bottom of the column there are two bolts for fixing the column to the chassis. Loosen the bolts enough to slide the column into the chassis until the red arrow on the front is pointing on the edge of the chassis (see picture). Tighten the bolts properly with the Allen key on the top of the column (see page 10) to fix the column to the chassis. Both bolts must be attached to chassis.



 *The QR2+ column has a pin in the bottom to be fitted in the chassis.*

- If the column stops before the arrow has reached the edge, you will have to retract the column and try turning the motor spline head to align it with the connector at the base of the column.

- Assemble the knee pad bracket on the column by removing the locking wheel. Place the knee pad bracket around the column and on the bolt where the locking wheel is placed and tighten the locking wheel. Make sure the bracket is placed with the level side up.

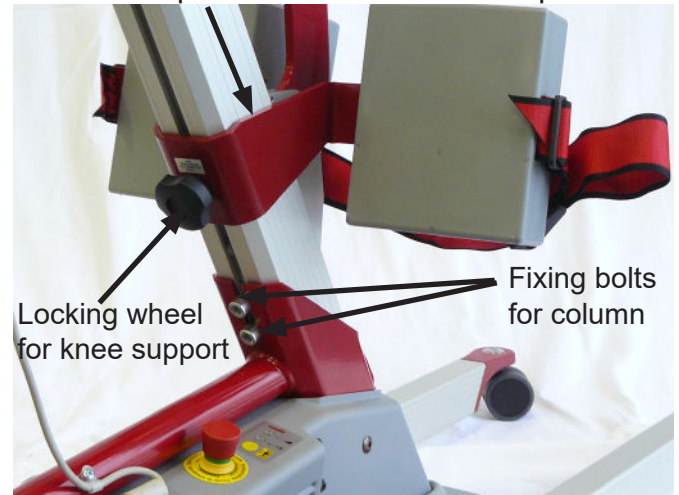

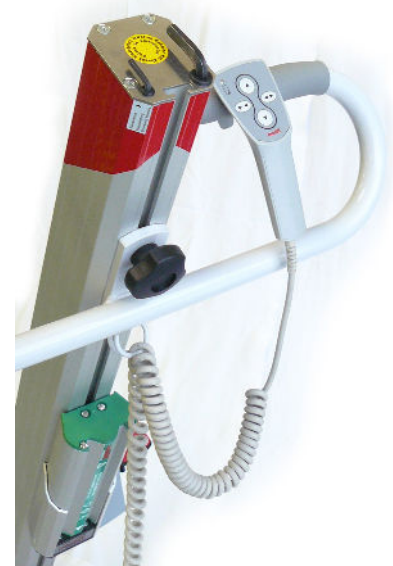

- Slide the driving handle onto the top of the column by guiding the head of the fixing knob into the T-groove of the column. The handle shall be pointing upwards, as shown on the picture below. Tighten the knob firmly when the handle is in the desired position.
- Guide the wire of the hand control through the ring at the base of the drive handle. The hand control has a hook enabling it to hang on the handle.

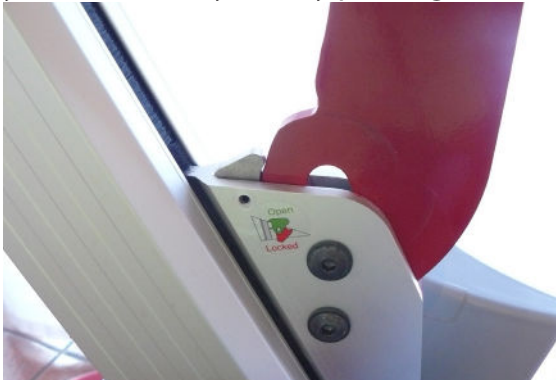

- Attach the lifting arm to the trolley on the column.

QR1 and QR2: On the trolley there is a small safety lock which has to be pushed up to ensure a correct attachment of the lifting arm on the trolley. Open the safety lock and then guide the arm in place over the two bolts in the trolley. Lock the safety lock by pushing it down.



 *Be careful not to put fingers or similar under the lifting arm between arm and trolley. Danger of personnel injury.*

QR2+: Place the lifting arm, install the bolt and attach with the screws. Torque 28 Nm. Secure screws with Loctite 2701.



- Place the battery in the battery holder with the connectors facing down. Run each function of the lifter a couple of times without load to verify that the lifter works.

 *Etac A/S Gedved tests all lifters with and without load before shipment. The control is an extra precaution to uncover any shipment damage and/or incorrect assembly.*

Checklist

- Verify that the lifting arm is properly fastened to the trolley.
- Verify that the lifting column is properly placed into the chassis - arrow shall be exactly aligned with the edge of the chassis.
- Verify that the column is properly fastened with bolts tightened.

 *Make sure that the lifter has no damage or cracks, and that the lifting arm and column is properly fixed before use!*

Disassembly

- Remove the battery.
- Remove the lifting arm by opening the security lock on the trolley at then pull out the lifting arm.
- Loosen the lock wheel for the drive handle and pull the handle with plate and locking wheel up and out of the column.
- Remove the locking wheel for the knee support and remove the complete knee support (also possible to leave on the column). Replace the locking wheel on the bolt on column to avoid it from getting lost.
- Loosen the column fixing bolts with Allen key and lift out the column.

Environment conditions

For long time storage it is recommended that the battery is removed and the emergency stop button is activated. The lifter can be stored and transported under the following conditions:

Pressure: 70 - 106 kPa

Humidity: 15 - 93 %

Temperature: -25 - 70 °C



The lifter is designed for use at standard room temperatures (+5 to +40°C). Following storage or transport at other temperatures leave the lifter in a room with a suitable temperature until it reaches a safe operating temperature.

Battery and charging

Battery care and charging

i *Recharge battery upon receipt, and then every six months, to avoid battery failure.*

Molift Quick Raiser is supplied with a battery with a 14,4 V cell unit that is placed in the battery holder on the lifter. A charger is also supplied to charge the battery whenever needed. The charger can be mounted on a wall surface or placed on a table.

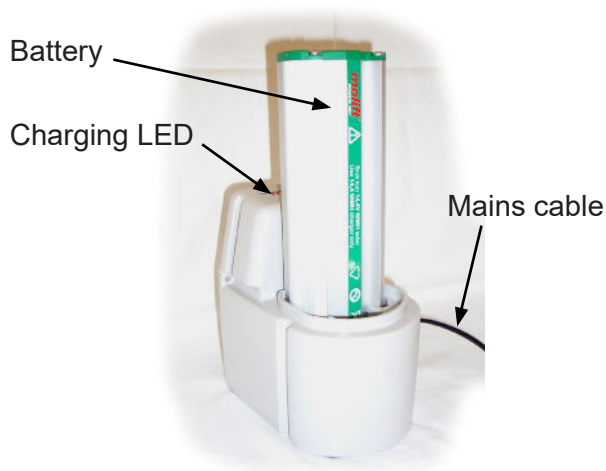

Connect the charger mains cable to the wall socket when charging the battery. The Charger must be placed or installed in a way that makes it easy to disconnect mains cable. Take care not to damage the cable. Charger has to be used outside the patient environment

Place the battery in the charger. After a few seconds the charger LED will change from yellow to orange, indicating that the battery is charging. When the LED gives a constant green light the battery is fully charged. The charger has a LED (Light Emitting Diode) indicating the status of the battery as described below:

LED	Mode
Yellow	No battery
Yellow	Initialization (10 sec)
Orange	Fast charge
Green/yellow	Top-off charge
Green	Trickle charge
Orange/green	Error

Battery capacity

The battery light on the hand control will illuminate if the voltage of the battery falls below a certain level, indicating the need for charging. There is still enough capacity to perform 3-5 lift cycles (75 kg) at this point. The battery lamp on the chassis will only illuminate when a hand control is not connected and the battery needs charging.

i *If the battery is discharged during a lift, it is always enough power to lower the user down again.*

i *New batteries will not achieve full capacity before it has been fully charged and discharged a couple of times.*

i *The battery has a life expectancy of approx. 500 charge cycles.*

Electrical system

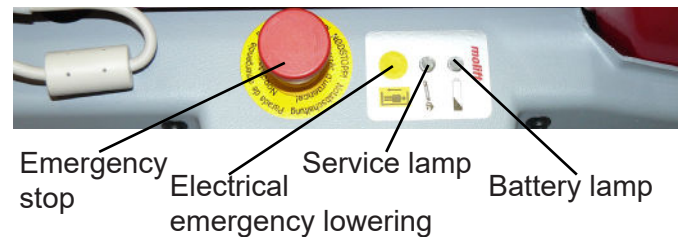

On the right side of the chassis there is a service light which will give a signal when the lifter needs service. When there is a green light, the lifter can be used normally. If there is no light, push one of the up/down buttons to activate the electronics, and the service lamp will illuminate. See the chapter "Maintenance".

The electronics has a power save-function which makes the system sleep after a while with no activity. All lights will go out. Activate the system by pushing one of the buttons on the hand control. If the lifter is run up and down constantly for a longer period, the electronics may be overheated and the lifter will stop. Let the lifter rest until the lifter is cooled down enough for further use.

i *Discarded lifters and batteries should be handled as electronic waste and collected separately according to local laws and regulations.*

Safety devices

Molift Quick Raiser is equipped with several safety devices, which are intended to prevent damage to personnel and equipment in case of incorrect use.

- The lifter has an overload sensor preventing the lifter to be operated with more than SWL.
- The lifting arm is hinged to prevent the arm from squeezing the patient if it is lowered too much.
- The lifting arm has rope locks on the lifting arms, designed to lock the ropes on the lifting strap when they are loaded.
- When activating the emergency stop button, the power supply will be disconnected, and the lifter will stop.
- If an error occurs, it is possible to lower the lifting arm manual or electrical.
- The lifter has a service lamp which gives a signal when the lifter needs service.

Emergency stop and emergency lowering



Contact a service partner if the cause of the stop or malfunction is unknown or if a fault is discovered. The lifter is to be taken out of service until the fault is repaired

Emergency stop

The emergency stop button is placed on the chassis. The emergency stop will cut the power supply to the motor when it is activated. Activate by pushing the emergency stop button in, and reset by turning the button clockwise until it pops up. Electrical emergency lowering does not work when emergency stop is activated.



Emergency stop

Electrical emergency lowering

Emergency lowering

It is possible to perform a emergency lowering if the lifter should malfunction. Molift Quick Raiser has both manual and electrical emergency lowering.

The manual lowering is done by turning the worm screw using an Allen key (this can be found on the top of the column). Puncture the label and use the small Allen key in the hole under the yellow label, turn the worm screw until the patient is lowered enough.

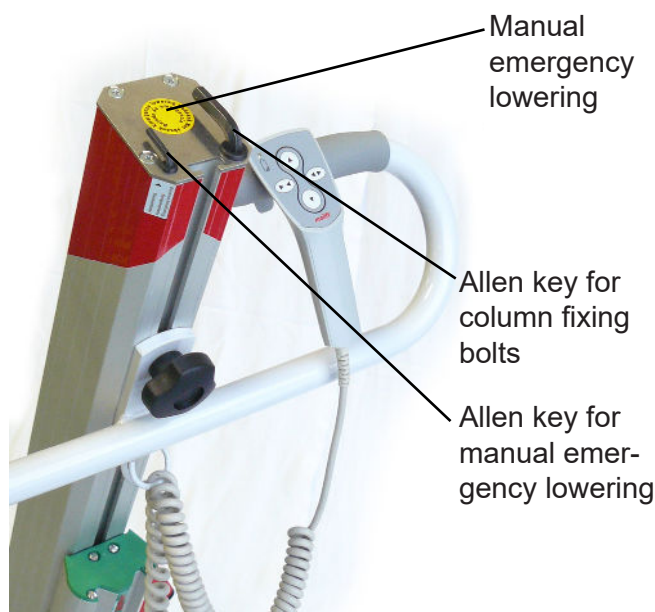

Manual emergency lowering

Allen key for column fixing bolts

Allen key for manual emergency lowering

Electrical emergency lowering can be found on the chassis. Push the emergency lowering button and lower the patient. Electrical emergency lowering does not work when the emergency stop is activated.



Replace labels if they are punctured to seal the lifter again.

Technical data Molift Quick Raiser 1

Weight, complete lifter:

excl. battery; 29 kg / incl. battery: 30 kg

Weight, disassembled:

Chassis, complete: 15,2 kg

Column complete: 10.8 kg

Lifting arm, V-shape: 2.9 kg

Lifting arm, U-shape: 2.4 kg

Material:

Aluminium, steel and plastics

Motor:

Lifting motor: 12 V DC

Battery:

14.4 V NiMH 2.6 Ah

Battery charger:

Mascot type 2215, 10-22 cells NiCd/NiMH

Protection:

IP24

Number of lift with fully charged battery:

40 lifts (75 kg, 50 cm)

Safe Working Load (SWL):

160 kg (560 lbs)

Lifting range:

0 - 850 mm under patient

Lifting speed:

50 mm/sec (75 kg)

Turning diameter:

1,100 mm

Sound level, max A-weighted sound power level:

$L_{WA} = 62$ dB

Operating forces:

Buttons on hand control: 3.4 N

Height of legs:

70 mm

Measurements:

1,070 x 610 x 1,280 mm (LxWxH)

All measurements in illustrations are in millimetres.

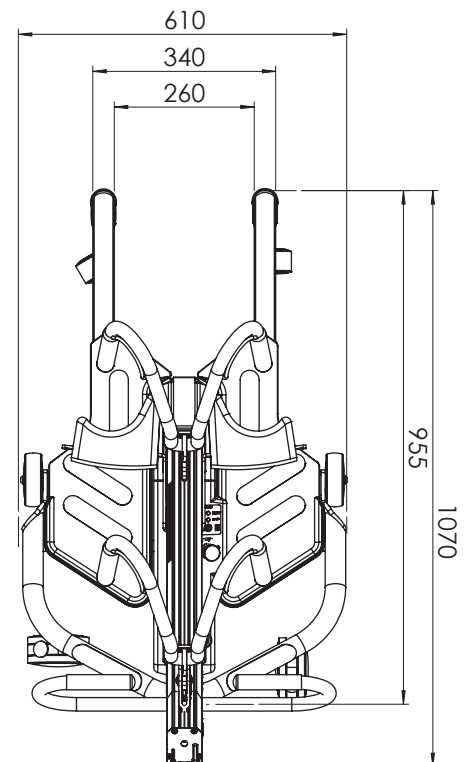
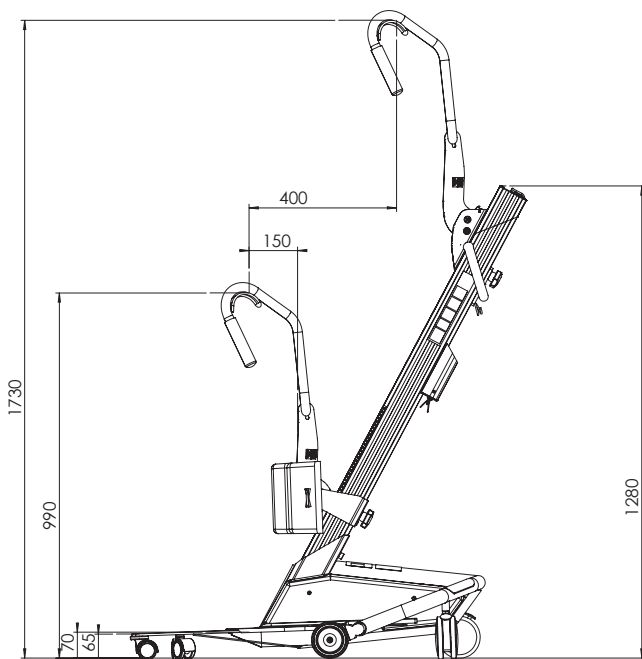
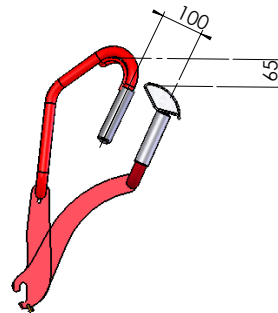

Technical data Molift Quick Raiser 2

Weight, complete lifter:

excl. battery; 36.5 kg /
incl. battery: 37.5 kg

Weight, disassembled:

Chassis, complete: 22 kg
Column complete: 11.7 kg
Lifting arm, V-shape: 2.9 kg
Lifting arm, U-shape: 2.4 kg

Material:

Aluminium, steel and plastics

Motor:

Lifting motor: 12 V DC
Leg spreading motor: 12 V DC

Battery:

14.4 V NiMh 2.6 Ah

Battery charger:

Mascot type 2215, 10-22 cells NiCd/NiMH

Protection:

IP24

Number of lift with fully charged battery:

40 lifts (75 kg, 50 cm)

Safe Working Load (SWL):

160 kg (560 lbs)

Lifting range:

0 - 850 mm under patient

Lifting speed:

50 mm/sec (75 kg)

Turning diameter:

1,450 mm

Sound level, max A-weighted sound power level:

$L_{WA} = 62$ dB

Operating forces:

Buttons on hand control: 3.4 N

Height of legs:

ca 100 mm

Measurements:

1,265 x 610 x 1,280 mm (LxWxH)

All measurements in illustrations are in millimetres.

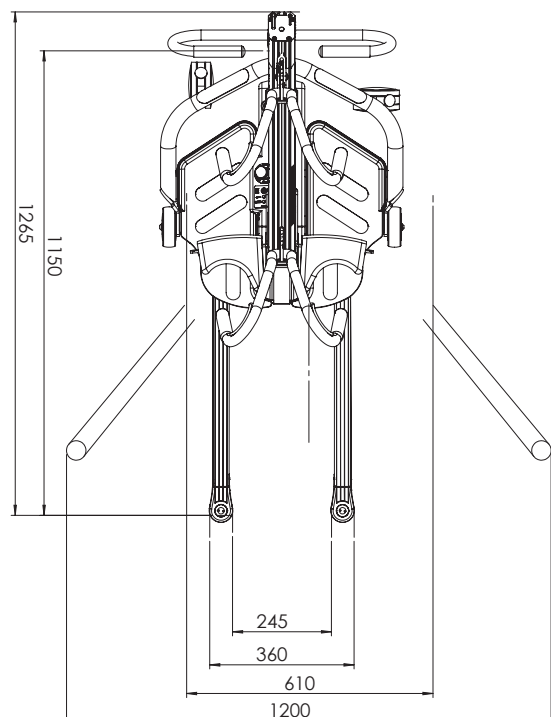
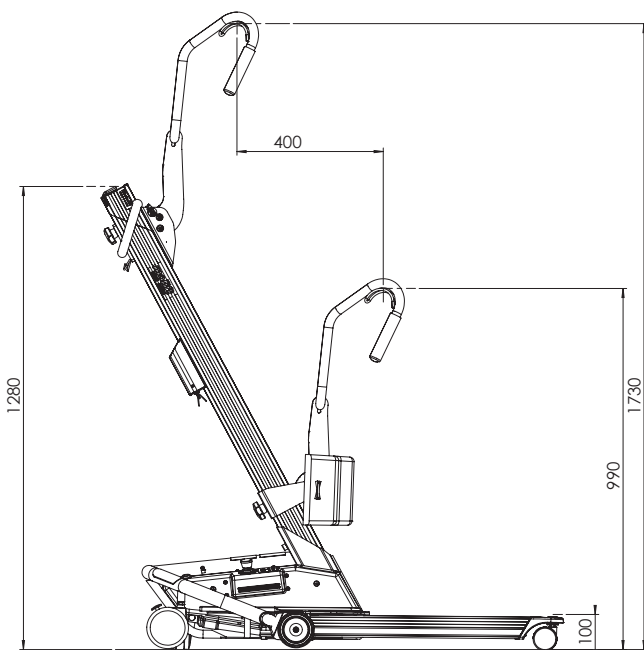
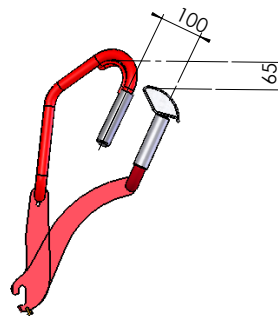

Technical data Molift Quick Raiser 2+

Weight, complete lifter:

excl. battery; 37.4 kg /
incl. battery: 38.4 kg

Weight, disassembled:

Chassis, complete: 22 kg
Column complete: 11.9 kg
Lifting arm, U-shape: 3.5 kg

Material:

Aluminium, steel and plastics

Motor:

Lifting motor: 12 V DC
Leg spreading motor: 12 V DC

Battery:

14.4 V NiMH 2.6 Ah

Battery charger:

Mascot type 2215, 10-22 cells NiCd/NiMH

Protection:

IP24

Number of lift with fully charged battery:

40 lifts (75 kg, 50 cm)

Safe Working Load (SWL):

200 kg (560 lbs)

Lifting range:

0 - 850 mm under patient

Lifting speed:

28 mm/sec (75 kg)

Turning diameter:

1,450 mm

Sound level, max A-weighted sound power level:

$L_{WA} = 62$ dB

Operating forces:

Buttons on hand control: 3.4 N

Height of legs:

ca 100 mm

Measurements:

1,265 x 610 x 1,280 mm (LxWxH)

All measurements in illustrations are in millimetres.

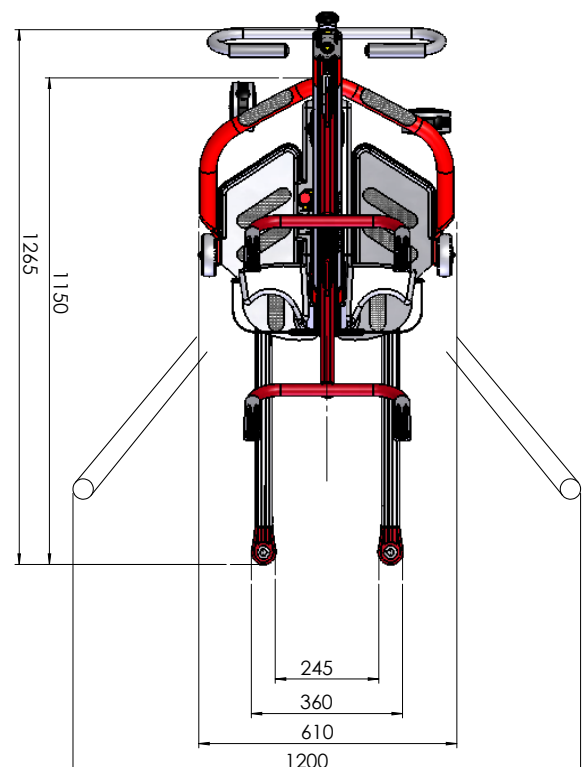
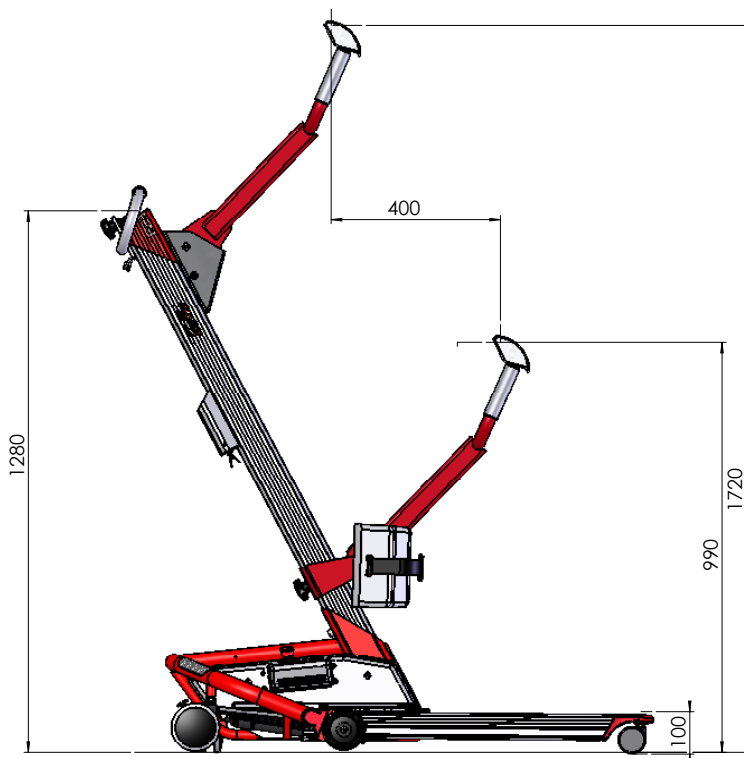

Labels and symbols

The Product labels barcode contain article number, serial number and production date.

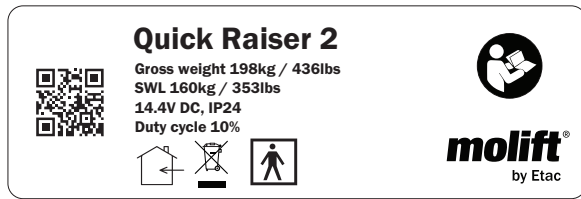

Symbols used on the product, explained in more detail:

- | | | | |
|--|---------------------------------|--|-------------------------|
| | Type BF applied part | | Battery light |
| | CE marked | | Certification body mark |
| | Refer to user manual | | Manufacturer |
| | Indoor use only | | Date of manufacture |
| | Do not dispose in general waste | | Catalogue number |
| | Emergency lowering | | Serial number |
| | Service light | | Medical Device |

On the left side of the column there is a short guide.

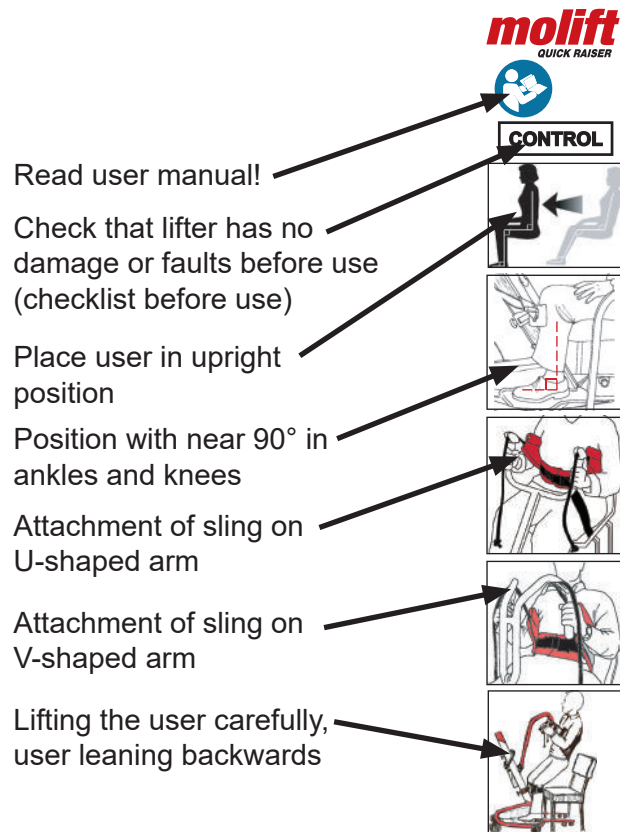

The safety control label is also placed on chassis behind the column.

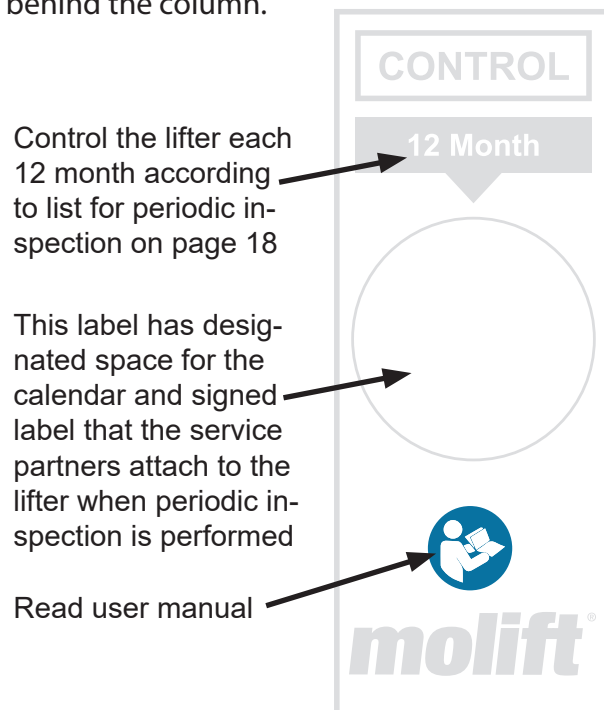

Accessories

Molift RgoSling StandUp

Size	Molift RgoSling StandUp
XS	1720710
S	1720720
M	1720730
L	1720740
XL	1720750

Molift RgoSling StandUp with support

Size	Molift RgoSling StandUp with support
XS	1720810
S	1720820
M	1720830
L	1720840
XL	1720850

Sling size guide

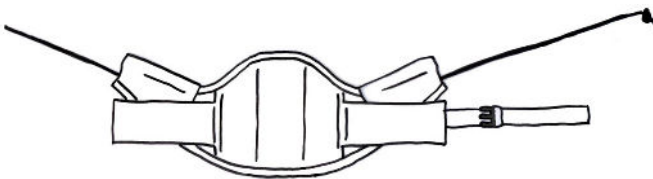

The strap is adjustable

Size	Colour code	Recommended weight (Kg)	Waist	
			min (cm)	max (cm)
XS	Light blue	20-30	50	65
S	Red	30-50	60	90
M	Yellow	50-90	75	110
L	Green	90-160	100	150
XL	Blue	160-200	120	180

i All lifting straps are approved for 200 kg, Recommended weight is only mentioned as a guide to choose the correct size.

Sling bag - Part no. 3048000

BM04101 - Rev I 20/05/2021

Quick Raiser Sandals

Pair of sandals, size Small

- Part no.: 452100

Pair of sandals, size Medium

- Part no.: 452200

Pair of sandals, size Large

- Part no.: 452300

Adjustable footplate

- Art no: 451000

Extra padding for knee support

Extra padding knee support, small

- Part no.: 0455111

Extra padding knee support, large

- Part no.: 0455114

Lifting arms

Arm complete V-shape

- Part no: 458107

Lifting arm for Molift Quick Raiser 1 and 2 (SWL 160 kg)

Arm complete U-shape

- Part no: 458010

Lifting arm for Molift Quick Raiser 1 and 2 (SWL 160 kg)



Troubleshooting

Below you will find a table with fault finding procedures to identify and correct faults on the lifter:

Symptom	Possible cause/action
Lifting column is wobbly	Locking bolts are not properly secured or lifting column is not properly in place in the chassis / <i>check if the column is correctly placed in the chassis and/or tighten bolts</i>
Lifter only moves one way (up or down) / legs only moves one way (in or out)	Fault on hand control / <i>exchange with alternative control from other lifter and/or new hand control</i>
	One of the relays / electronics has failed/ exchange the control unit/relays / <i>contact your local service representative</i>
The lifter moves up and/or down by itself / legs move by themselves	Short circuit between the hand control and lifter / <i>clean the connectors of the hand control and chassis with spirits to remove grease and dirt</i>
	The hand control has failed/ exchange hand control / <i>contact your local service representative</i>
	Relays/electronics malfunctions / <i>exchange electronics/relays / contact your local service representative</i>
The lifting arm does not move / legs does not move	Discharged battery / <i>exchange battery with another or charge battery</i>
	Bad or wobbly connection from lifting column to chassis / <i>clean contacts in column base and inside chassis - adjust and tighten column bolts</i>
	Emergency stop activated / <i>turn clock wise to reset</i>
	Hand control disconnected / <i>re-connect hand control</i>
	The hand control has failed/ exchange hand control / <i>contact your local service representative</i>
	Relays/electronics malfunctions / <i>exchange electronics/relays / contact your local service representative</i>
	Motor has failed / <i>exchange motor / contact your local service representative</i>

If you have access to more than one lifter, it may be helpful to change parts across lifters to help identify any faults. For instance, if you suspect the fault to be inside the column, exchange the column with a functional one from the other lifter to see if the problem is fixed.

If you are not able to solve the fault or problems by yourself using this manual, please contact local authorised service representative. If you do not know whom to contact locally, please contact your dealer or Etac A/S Gedved to get help.

Warranty notice



Two-year warranty against defects in workmanship and materials of our products. One-year warranty for batteries. Please refer to www.etac.com for terms and conditions.

Maintenance

Cleaning

i *Detergents must be pH-neutral. Do not use solvents or strong liquids - this may damage surfaces on the lifter. For disinfection when needed; use isopropyl alcohol. Avoid abrasive cleaning products.*

Clean surfaces with a damp cloth using an appropriate detergent. Regular cleaning is recommended and should accordingly be added to internal routines.

Inspection should be performed to uncover unexpected damages or errors.

Monthly maintenance

- Check that the lifter has no loose parts or visible damages.
- Remove hair and pile from the castors and verify that the castors rotates without abnormal friction
- Verify that the contacts of the hand control and charger is firmly in place
- Clean contact and hand control with spirit or similar to remove grease and dirt
- Verify that the cables for the hand control, actuator and charger are intact
- Run the lifter up and down to verify that it runs normally.
- Take contact with your local Molift service representative/dealer if there are faults or errors.

Periodic inspection

Molift recommend periodic inspection of the lifter once a year according to checklist on page 18. Periodic inspection is to be performed by authorized personnel.

One checklist is to be filled in and signed for each lifter after inspection. The owner of the lifter is responsible for keeping the list for information.

Service

The lifter has a service lamp on chassis which will give a signal when service of the lifter is required. The service lamp gives a green light when the lifter can be used normally.

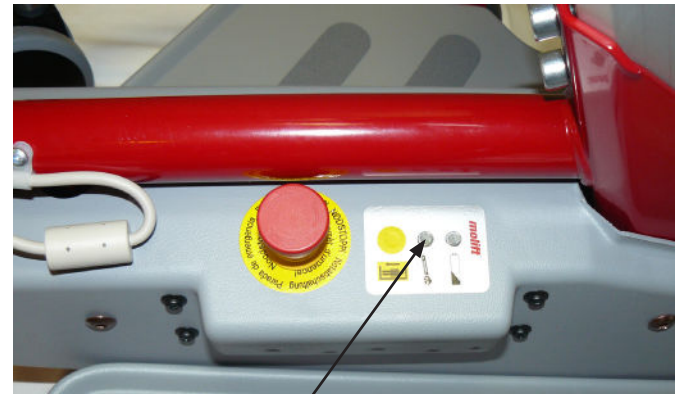

Service lamp

The electronics measures the operating time of the lifter, and after a specific time the service lamp will give a signal, first yellow light then red - indicating that the lifter needs service. Take contact with your local Molift service representative/dealer. The lifter can still be operated, but after a while an audible alarm will sound, to remind the operator that the lifter needs service immediately.

Service light codes

Service light	Mode
No light	Power saving
Green	Ready for use
Yellow	Book service
Red	Perform service
Red + sound	Perform service immediately
Flashing yellow	Overheating

Service includes control and change of worn or damaged parts.

The service partner uses the Molift Service Tool to read the data from the lifter, and for logging service and resetting the service LED. The owner is responsible to ensure proper logging and written verification performed by authorised service partner.

A list of spare parts is available on request

Checklist for periodic inspection of Molift Personal Lifters
Molift Quick Raiser 1, 2 and 2+
Revision C – 12/2008

COMPULSORY SAFETY CHECK (annual):

OK	Fault	Corrected	Visual inspection
			Whole lifter checked for damage, cracks and deformation and found to be in good order. (Especially raising arm, trolley with bolt, column, chassis, wheels and all cables).
			Lifter has been correctly assembled and no parts are missing. (Especially column attachment, knee supports and raising arm).
			Accessories have been checked. See separate form for sling. Battery charger is an accessory. List the accessories checked:.....
			Function checks
			Emergency stop and manual control have been checked and are in working order.
			The lifter has been rolled over the floor (preferably under load) and moves easily and steadily.
			Leg extender mechanism (Quick Raiser 2 and 2+) has been fully extended and retracted (preferably under load), and moves evenly and without noise (stops in correct positions).
			The lifter has been fully raised and lowered (preferably under load) and moves evenly and without noise.
			Servicing required
			Servicing unnecessary because the servicing lamp is on green and the lifter is under 5 years old.

Completed	Compulsory in case of faults under one of the above points:
	The lifter has been removed from service and clearly marked "OUT OF ORDER".
	Certified personnel have been summoned to carry out repairs and servicing. Name /Tel./ Fax:.....

Completed	Compulsory where lifter has been checked and approved:
	The lifter has passed the safety check and been affixed with the Molift safety check label, duly dated and signed.
	The ticked and signed checklist has been passed to the client and a copy sent to your Molift dealer.

Comments on faults and repairs:

.....

.....

.....

Lifter serial no.: Other ID. no. (if any):

Client:.....

Inspection carried out by: (Block capitals) from.....

Molift certification no. (if any) for inspector/repairer:

The equipment has been tested and is in full working order Yes No

Place: Date: Signature:



Etac A/S
Parallevej 3
DK-8751 Gedved
www.etac.com

molift[®]
by Etac